

Electrical Characteristics										
Frequency	Hz	50				60				
Voltage (parallel star)	V	380	400	415	440	415	440	460	480	
Rated power class H	kVA	750	750	750	-	860	900	900	900	
	kW	600	600	600	-	688	720	720	720	
Rated power class F	kVA	690	690	690	-	790	830	830	830	
	kW	552	552	552	-	632	664	664	664	
Regulation with	DER1	±1% with any power factor and speed variations between -5% +30%								
Insulation class		H								
Execution		Brushless								
Stator winding		12 ends								
Rotor		with damping cage								
Efficiencies class H	4/4	%	94,8	95,1	94,9	-	95,8	96,1	96,5	96,6
(see graph. for details)	3/4	%	95,1	95,3	95,1	-	95,9	96,3	96,7	96,8
	2/4	%	94,2	94,4	94,2	-	94,8	95,1	95,4	95,6
	1/4	%	91,5	91,6	91,4	-	91,4	91,7	92	92,2
Reactances (f. l.cl. F)										
	Xd	%	185	170	158	-	230	200	185	170
	Xd'	%	17,7	16,4	15,6	-	20,4	18,7	17,7	16,4
	Xd''	%	9,6	8,7	8,1	-	11,8	10,4	9,6	8,7
	Xq	%	128	118	107	-	159	139	128	118
	Xq'	%	128	118	107	-	159	139	128	118
	Xq''	%	15,1	14,3	12,6	-	17,3	16,2	15,1	14,3
	X ₂	%	13,3	12,1	11,1	-	15,4	14,1	13,3	12,1
	X ₀	%	2,7	2,2	2	-	3,4	3,1	2,7	2,2
Short Circuit Ratio	Kcc		0,54	0,59	0,63	-	0,42	0,50	0,54	0,59
Time Constants	Td'	sec.	0,18							
	Td''	sec.	0,015							
	Tdo'	sec.	3,70							
	Tα	sec.	0,071							
Short Circuit Current Capacity		%	>300				>350			
Excitation at no load	Amp.		0,4	0,6	0,8	-	0,4	0,5	0,55	0,6
Excitation at full load	Amp.		3,1	3,2	3,3	-	2,8	3	3,1	3,2
Overload (long-term)		%	1 hour in a 6 hours period 110% rated load							
Overload per 20 sec.		%	300							
Stator Winding Resistance (20°C)	Ω		0,0075							
Rotor Winding Resistance (20°C)	Ω		1,592							
Exciter Resistance (20 °C)	Ω		Rotor : 0,050				Stator : 8,85			
Heat dissipation at f.l.cl.H	W		32911	30915	32244	-	30163	29220	26114	25342
Telephone Interference			THF < 2%				TIF < 40			
Radio interference			EN61000-6-3, EN61000-6-2. For others standards apply to factory							
Waveform Distors.(THD) at f. load	LL/LN %		2,2 / 2,2							
Waveform Distors.(THD) at no load	LL/LN %		2,5 / 2,5							
Mechanical characteristics										
Protection			IP 21 (other protection on request)							
DE bearing			6322							
NDE bearing			6318.2RS							
Weight of wound stator assembly	kg		685							
Weight of wound rotor assembly	kg		449							
Weight of complete generator	kg		1693							
Maximun overspeed	rpm		2250							
Unbalanced magnetic pull at f.l.cl.F	kN/mm		6,9							
Cooling air requirement	m ³ /min		54				64,8			
Inertia Constant (H)	sec.		0,163				0,195			
Noise level at 1m/7m	dB(A)		94 / 82				98 / 88			

All technical data are to be considered as a reference and they can be modified without any notice.

This document is a propriety of Mecc Alte S.p.A.. All rights reserved.



GENERATOR TYPE ECO 40-VL/4

Document : **DS108A/2**
 issue 004 date : 21/03/2014

50 Hz

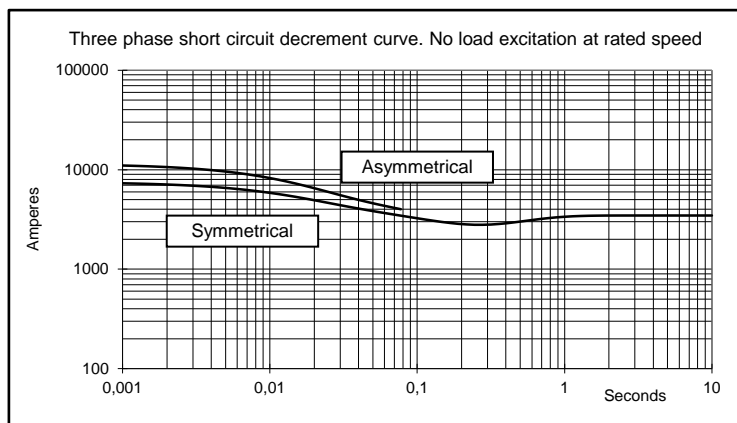
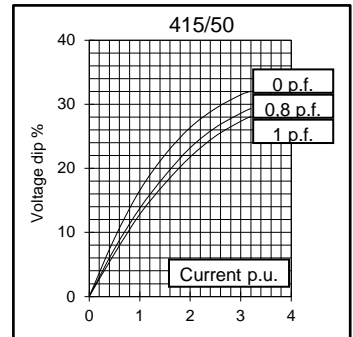
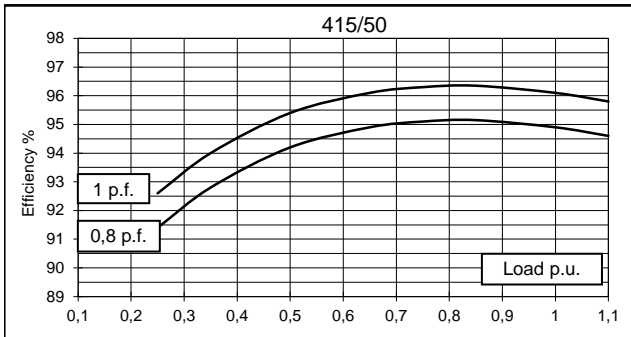
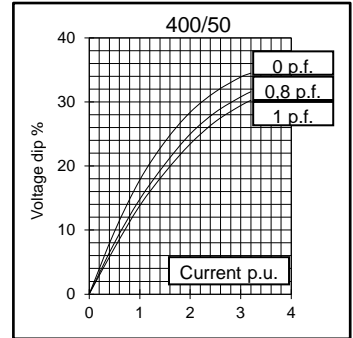
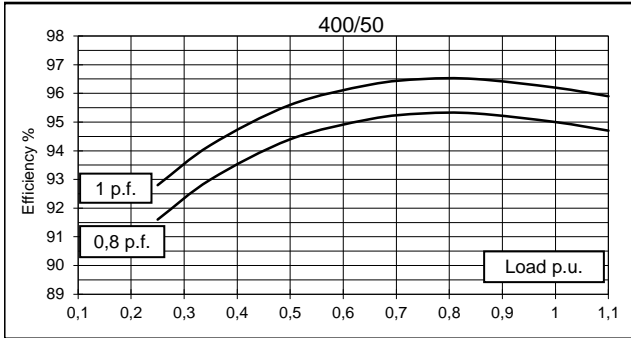
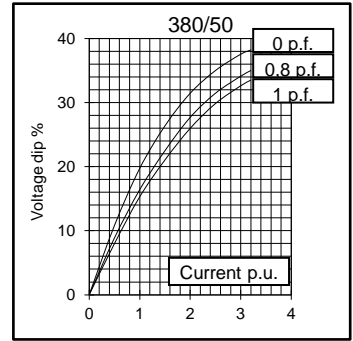
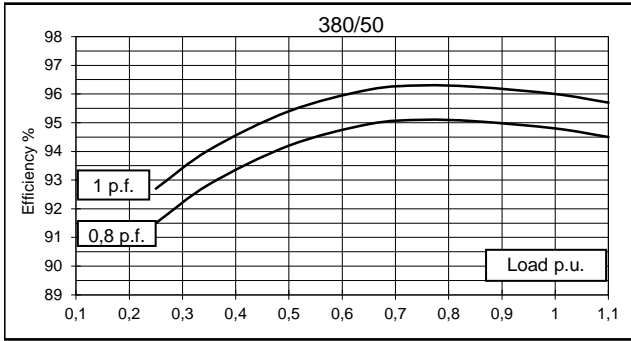

60 Hz

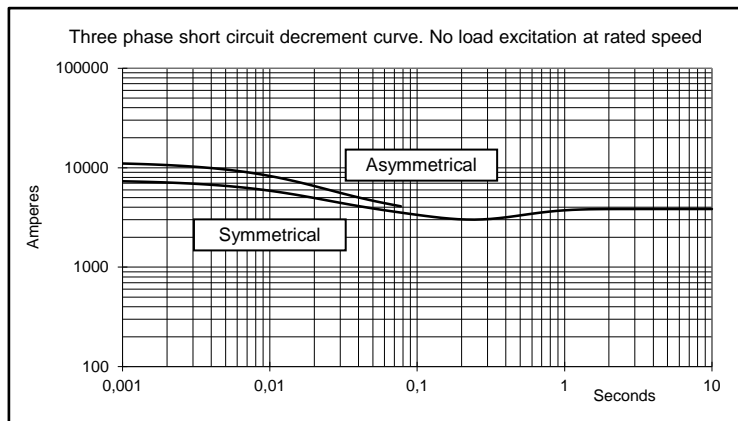
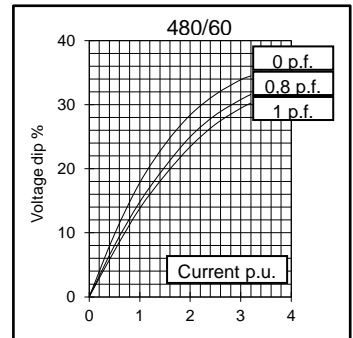
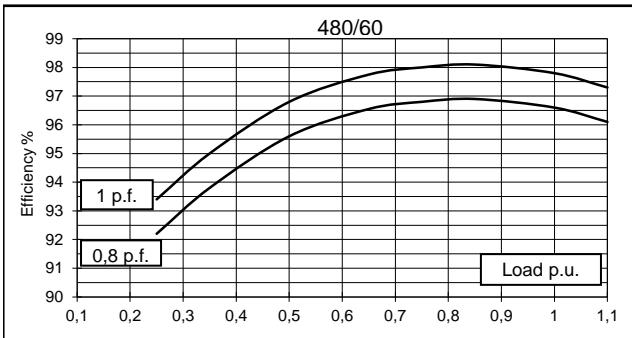
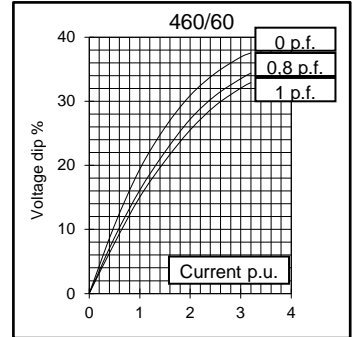
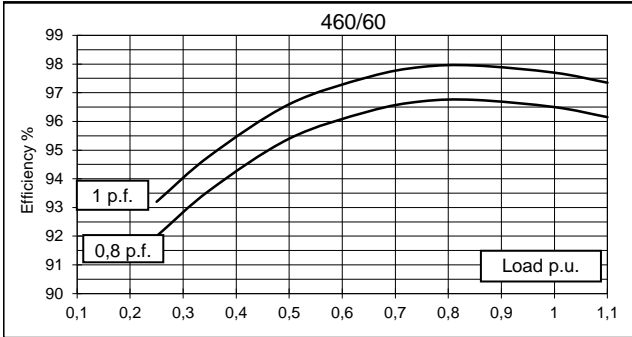
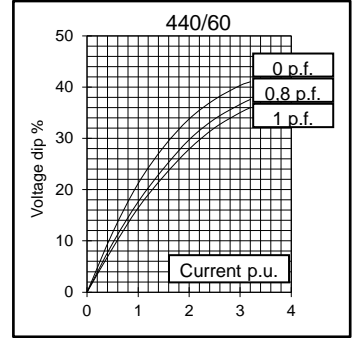
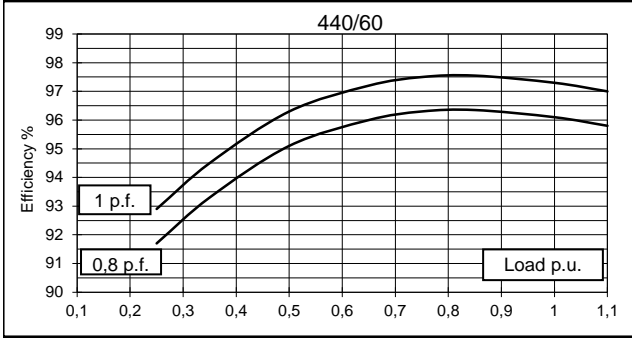
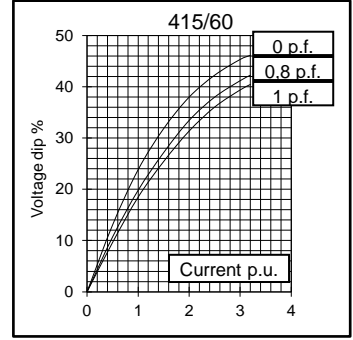
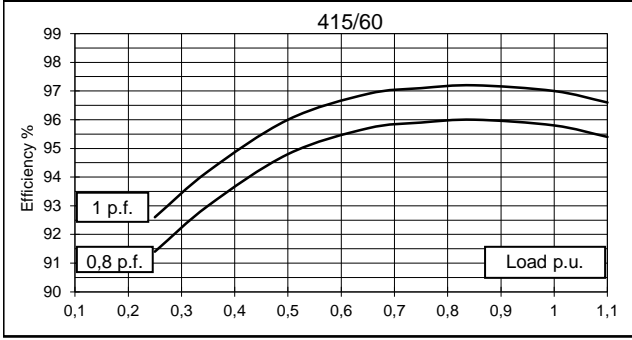

SINGLE BEARING MOMENTS OF INERTIA

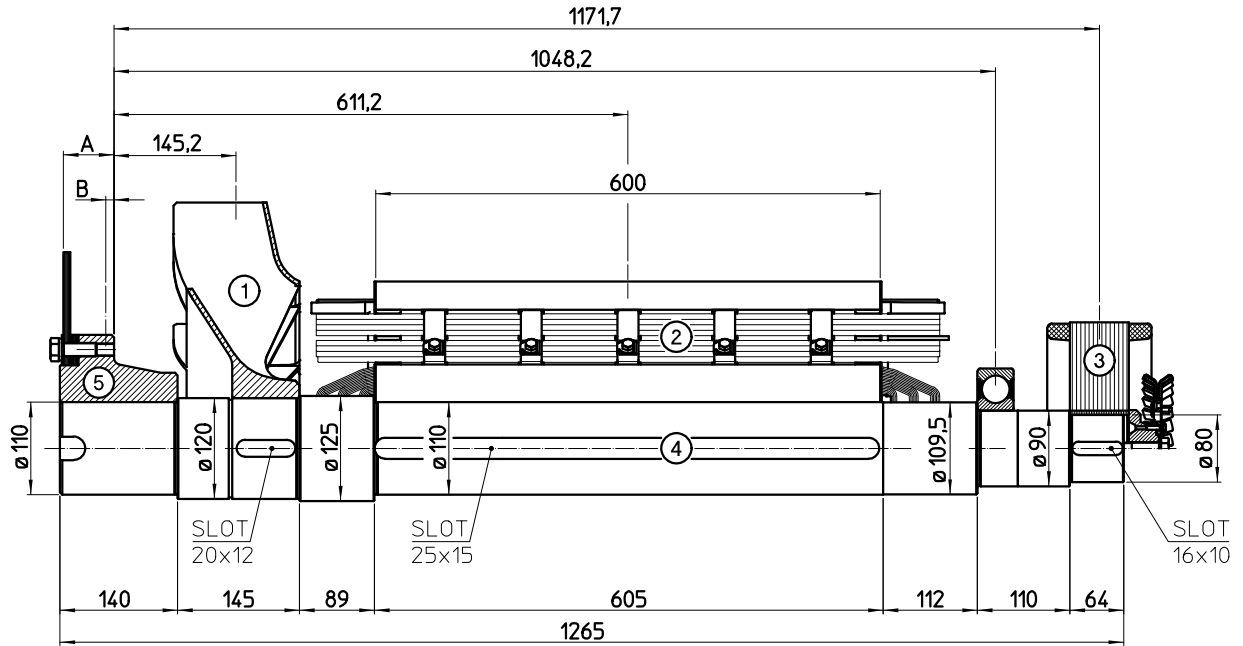

COMPONENT	WEIGHT kg	J kgm ²
1 FAN	10,2	0,335
2 MAIN ROTOR	449	8,838
3 EX. ROTOR	35	0,562
4 SHAFT	91,6	0,140
TOTAL	585,8	9,875

Sae No	SHAFTS COUPLING FLEX PLATE		
	A	B	WEIGHT kg
14	60	9,6	41,4
18	50	6,6	45,1

SINGLE BEARING DIMENSIONS

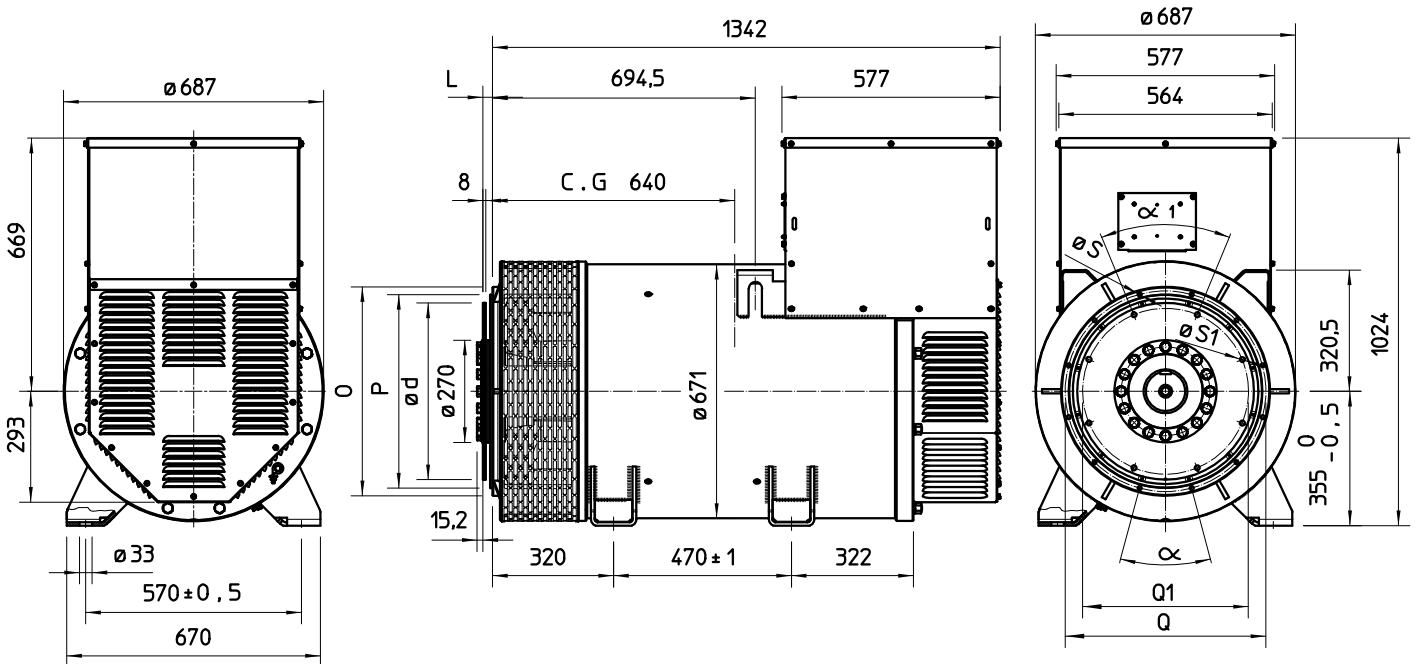

SAE N.	FLANGIA / FLANGE BRIDE / FLANSCH					
	O	P	Q	N. FORI	S	α
1	552	511,2	530,2	12	11	30°
1/2	648	584,2	619,1	12	14	30°
0	711	647,7	679,5	16	14	22,5°
00	883	787,4	850,9	16	14	22,5°

VOL. N.	GIUNTI A DISCHI / DISC COUPLING DISQUE DE MONOPALIER / SCHEIBENKUPPLUNG					
	L	d	Q1	N. FORI	S1	α1
14	25,4	466,72	438,15	8	14	45°
18	15,7	571,5	542,92	6	17	60°

C.G.= GRAVITY CENTER