

<b>Electrical Characteristics</b>										
Frequency	Hz	50				60				
Voltage (series star)	V	380	400	415	440	415	440	460	480	
Rated power class H	kVA	50	50	50	40	58	60	60	60	
	kW	40	40	40	32,0	46,4	48	48	48	
Rated power class F	kVA	48	48	48	38	56	58	58	58	
	kW	38,4	38,4	38,4	30,4	44,8	46,4	46,4	46,4	
Regulation with SR7/2		±1,5 % with any power factor and speed variations between -5% +30%								
Insulation class		H								
Execution		Brushless								
Stator winding		12 ends								
Rotor		with damping cage								
Efficiencies class H	4/4	%	89	89,1	88,8	88,6	91,1	91,6	91,7	91,8
(see graph. for details)	3/4	%	89,2	89,5	89,4	89,1	91,5	91,7	91,9	92,1
	2/4	%	87,5	87,6	87,6	87,4	88,8	88,9	89	89,1
	1/4	%	85,5	85,3	85,1	84,6	85,4	85	85,5	85,4
Reactances (f. l.cl. F)	Xd	%	271,5	245	227,6	162,0	316,8	291,6	266,8	245
	Xd'	%	14,96	13,5	12,54	8,93	17,46	16,07	14,70	13,5
	Xd''	%	8,20	7,4	6,87	4,89	9,57	8,81	8,06	7,4
	Xq	%	113,0	102	94,8	67,4	131,9	121,4	111,1	102
	Xq'	%	113,0	102	94,8	67,4	131,9	121,4	111,1	102
	Xq''	%	34,9	31,5	29,3	20,8	40,7	37,5	34,3	31,5
	X <sub>2</sub>	%	23,27	21	19,51	13,88	27,16	24,99	22,87	21
	x <sub>0</sub>	%	3,21	2,9	2,69	1,92	3,75	3,45	3,16	2,9
Short Circuit Ratio	Kcc		0,62	0,71	0,73	1,30	0,40	0,48	0,62	0,71
Time Constants	Td'	sec.	0,059							
	Td''	sec.	0,013							
	Tdo'	sec.	1,40							
	Tα	sec.	0,035							
Short Circuit Current Capacity		%	>300				>350			
Excitation at no load	Amp.		0,6	0,7	0,8	1,2	0,3	0,4	0,5	0,6
Excitation at full load	Amp.		2,2	2,4	2,3	2,7	2,1	1,9	2,1	2,3
Overload (long-term)		%	1 hour in a 6 hours period 110% rated load							
Overload per 20 sec.		%	300							
Stator Winding Resistance (20°C)	Ω		0,061							
Rotor Winding Resistance (20°C)	Ω		2,473							
Exciter Resistance (20 °C)	Ω		Rotor : 0,442				Stator : 11,35			
Heat dissipation at f.l.cl.H	W		4944	4893	5045	4117	4533	4402	4345	4288
Telephone Interference			FHT < 2%				TIF < 45			
Radio interference			EN50081-1, EN50082-1, VDE0875K. For others standards apply to factory							
Waveform Distors.(THD) at f. load	LL/LN %		3,8 / 3,6							
Waveform Distors.(THD) at no load	LL/LN %		3,3 / 3,2							
<b>Mechanical characteristics</b>										
Protection			IP 21 (other protection on request)							
DE bearing			6312-2RS							
NDE bearing			6309-2RS							
Weight of wound stator assembly	kg		78							
Weight of wound rotor assembly	kg		53							
Weight of complete generator	kg		248							
Maximun overspeed	rpm		2250							
Unbalanced magnetic pull at f.l.cl.F	kN/mm		4,1							
Cooling air requirement	m <sup>3</sup> /min		11,8				14,5			
Inertia Constant (H)	sec.		0,105				0,125			
Noise level at 1m/7m	dB(A)		75 / 60				79 / 64			

**50 Hz**

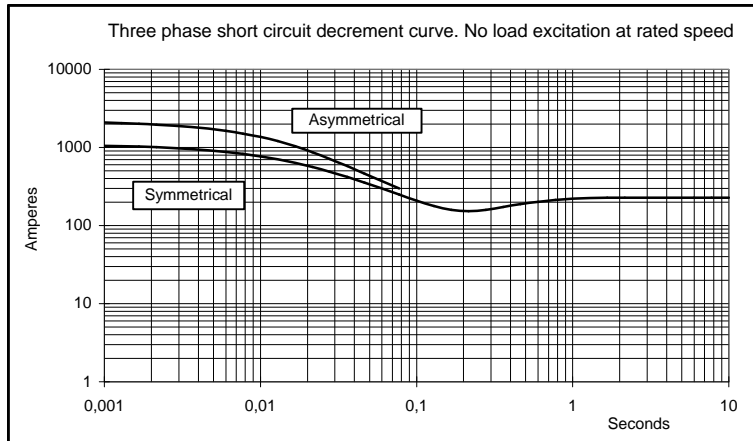

**60 Hz**

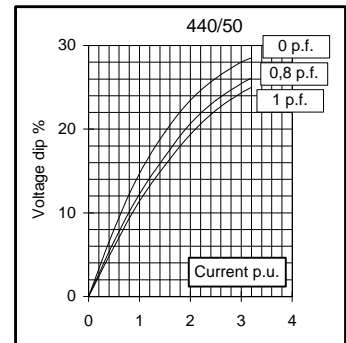
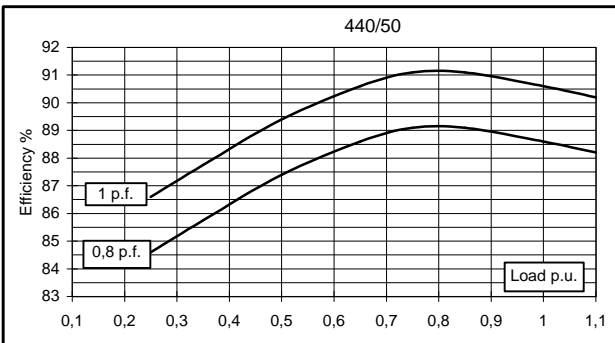
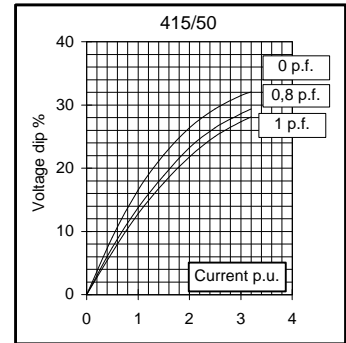
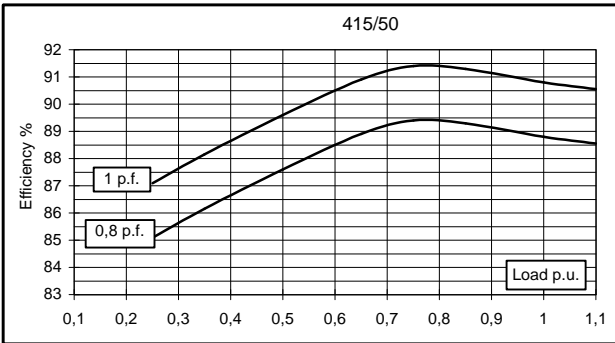
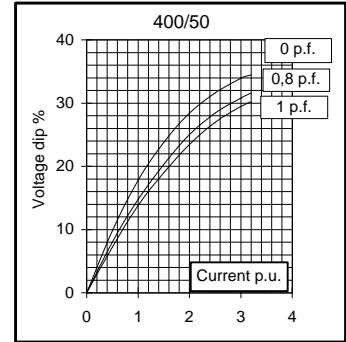
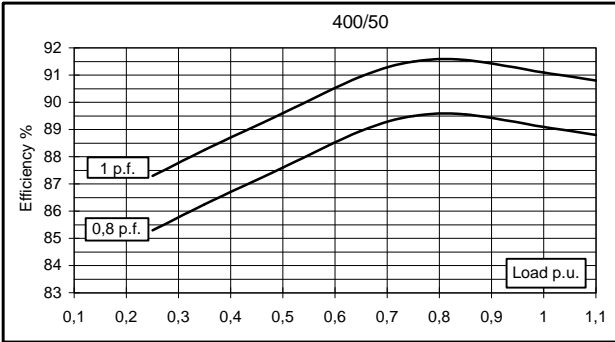
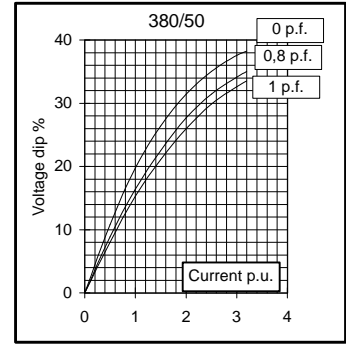
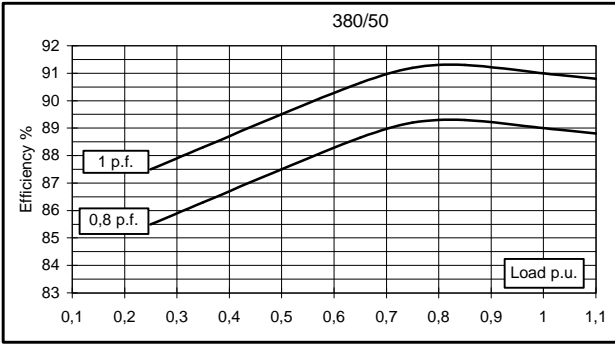
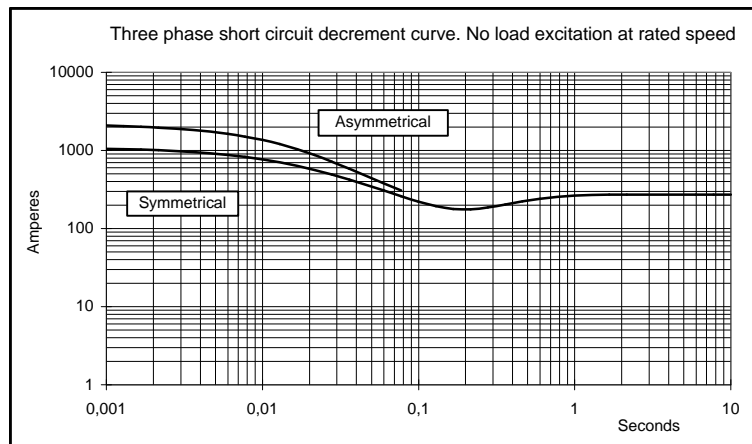
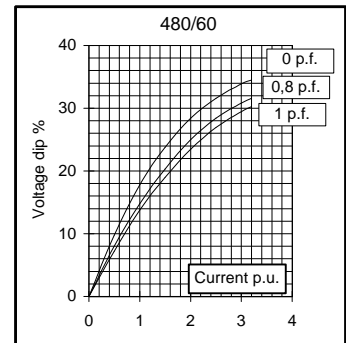
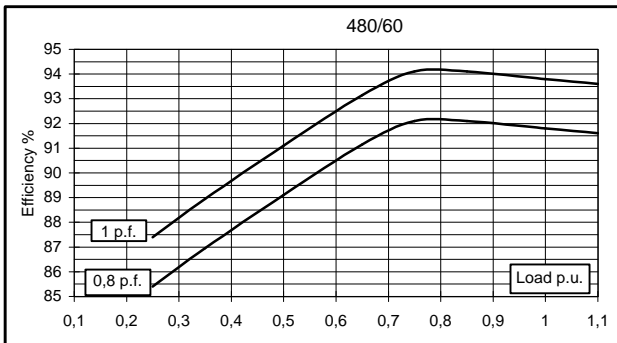
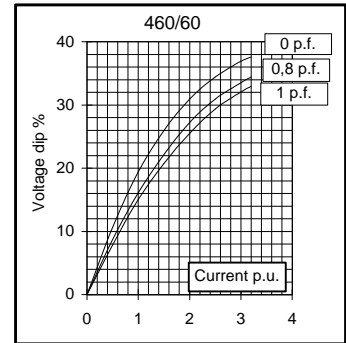
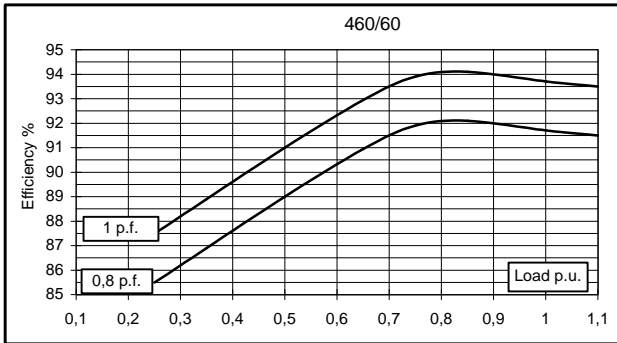
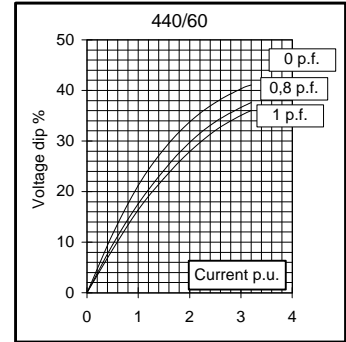
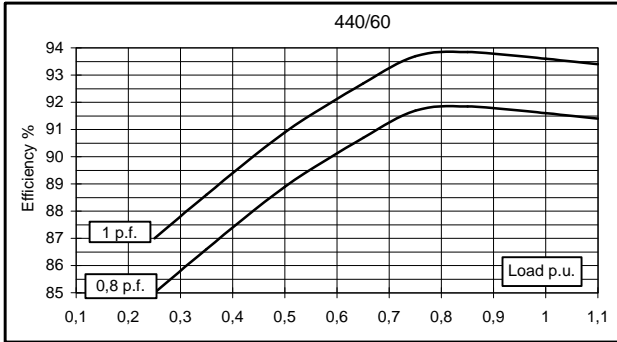
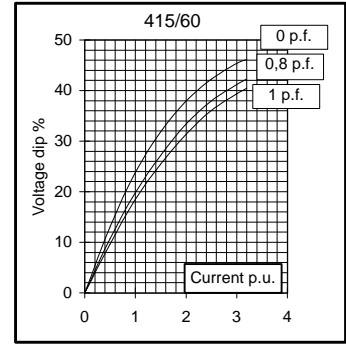
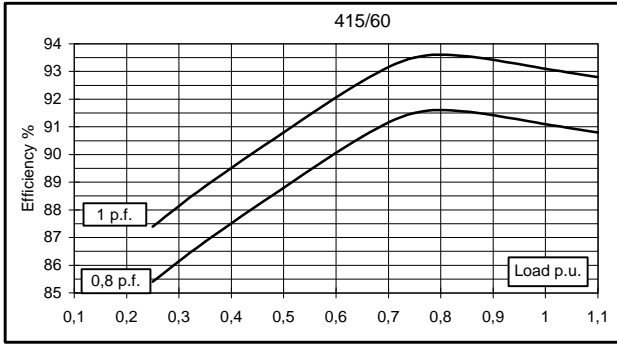

## TWO BEARING MOMENTS OF INERTIA

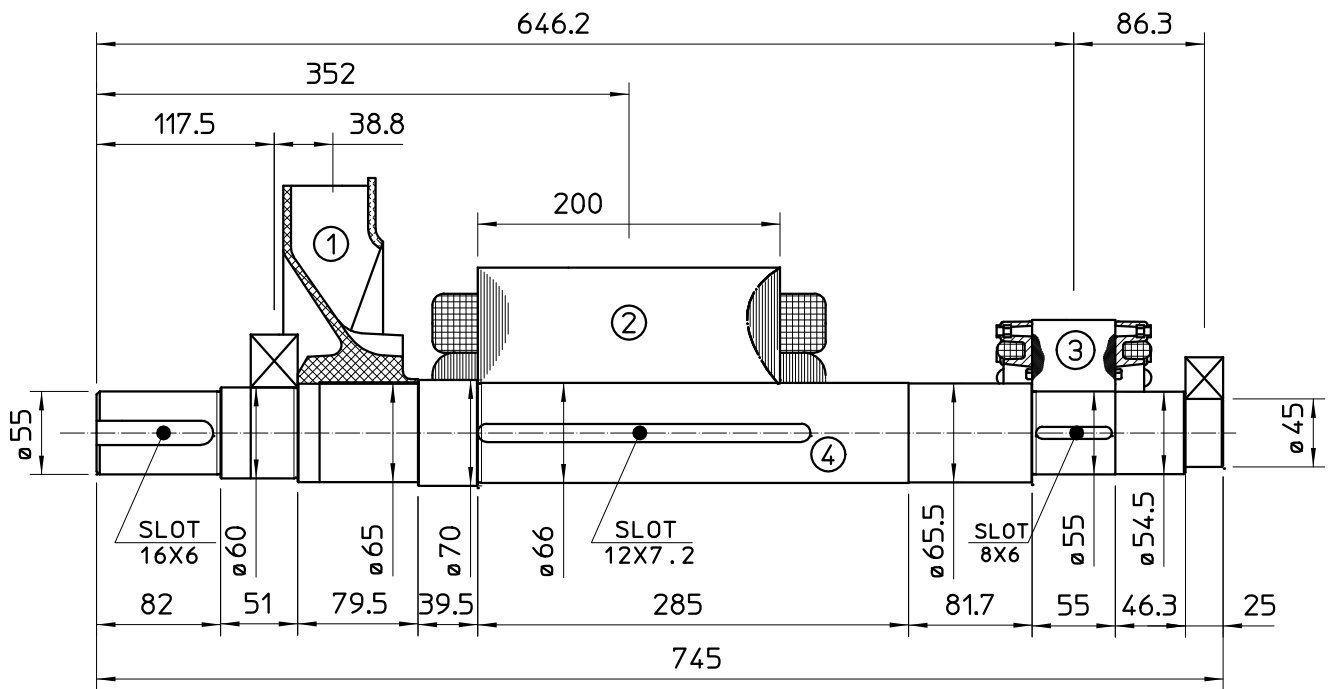

COMPONENT	WEIGHT kg	J $\text{kgm}^2$
1 FAN	2,3	0,0224
2 MAIN ROTOR	53	0,3763
3 EX. ROTOR	7	0,016
4 SHAFT	17,5	0,008
TOTAL	79,8	0,4227

## TWO BEARING DIMENSIONS

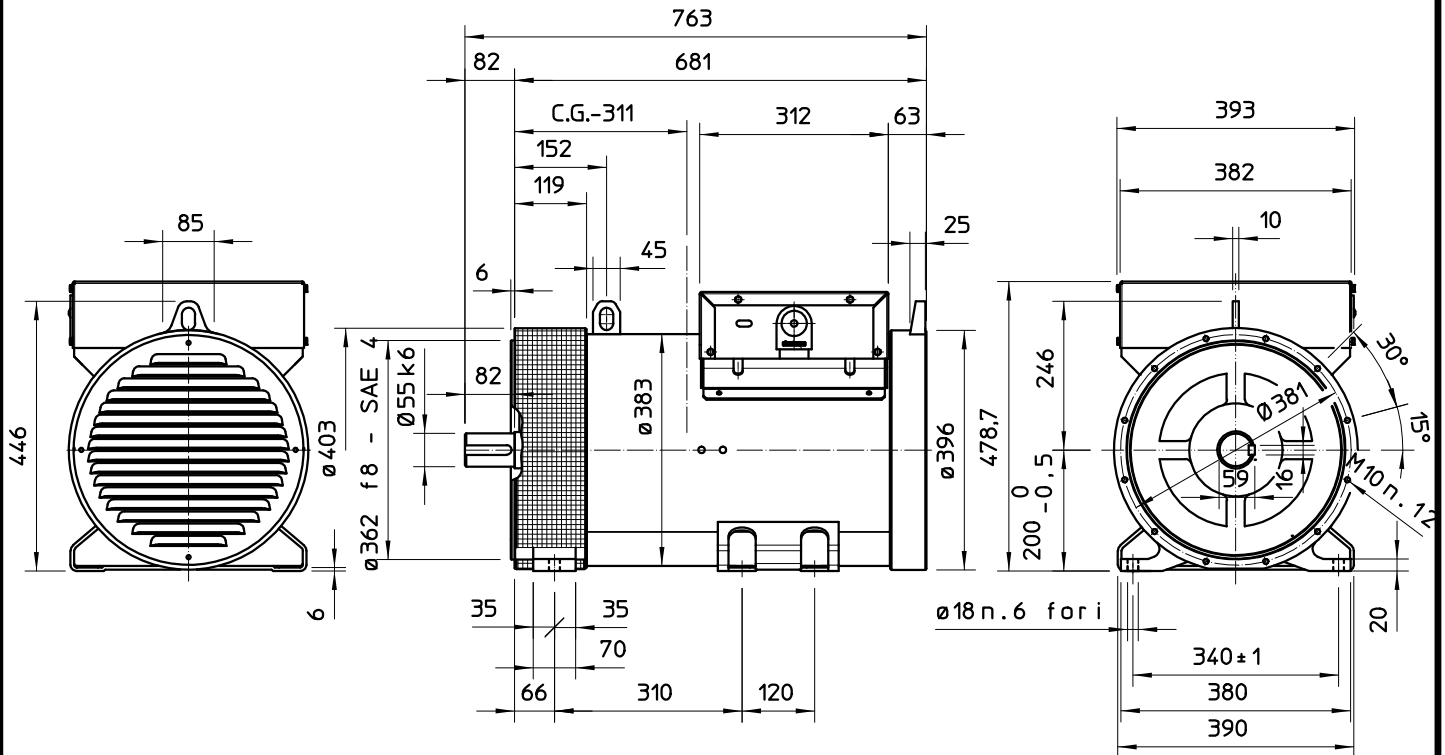

C.G. = GRAVITY CENTER

# SINGLE BEARING MOMENTS OF INERTIA

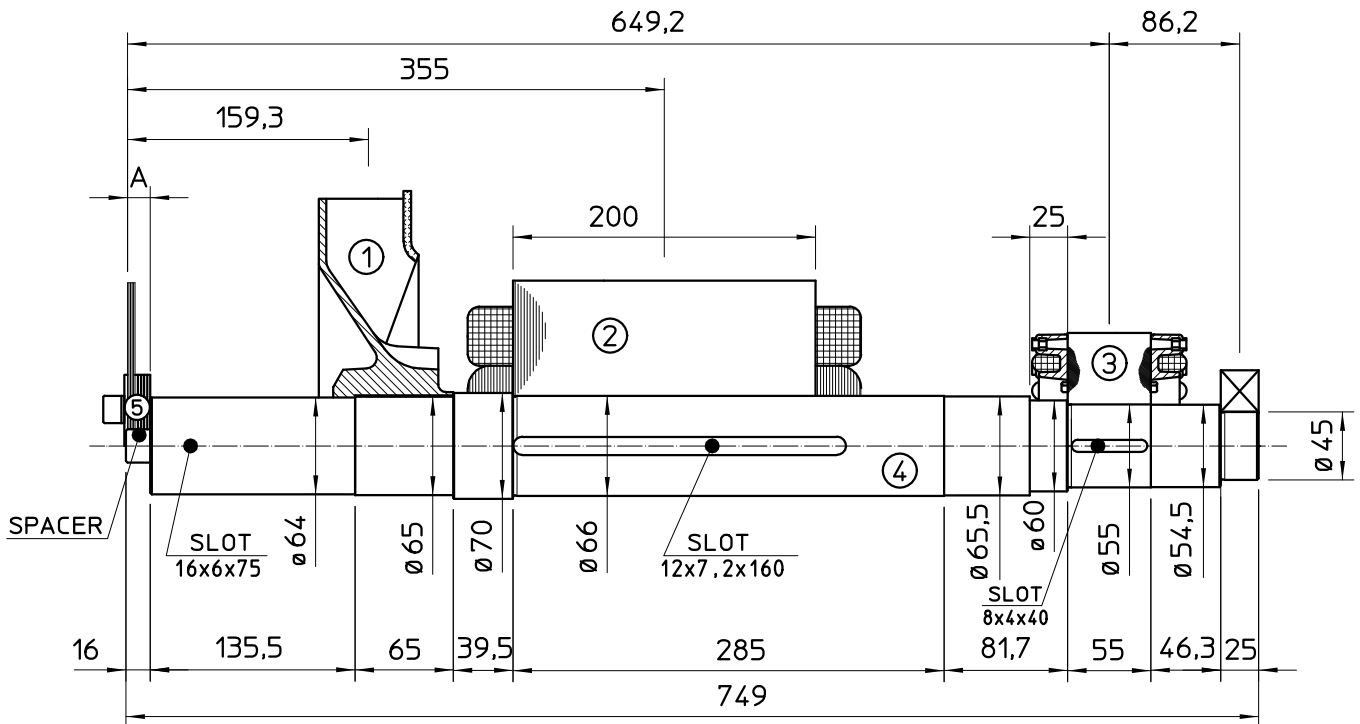

COMPONENT	WEIGHT kg	J kgm <sup>2</sup>
1 FAN	2,3	0,0224
2 MAIN ROTOR	53	0,3763
3 EX. ROTOR	7	0,016
4 SHAFT	18,3	0,0094
TOTAL	80,6	0,4241

SAE No	SHAFTS COUPLING FLEX PLATE			
	A (mm)	WEIGHT kg	J kgm <sup>2</sup>	
6,5	5	1,74	0,0084	
7,5	5	2,1	0,013	
8	36,6	3,9	0,02	
10	28,6	4,47	0,038	
11,5	15	4,51	0,059	

# SINGLE BEARING DIMENSIONS

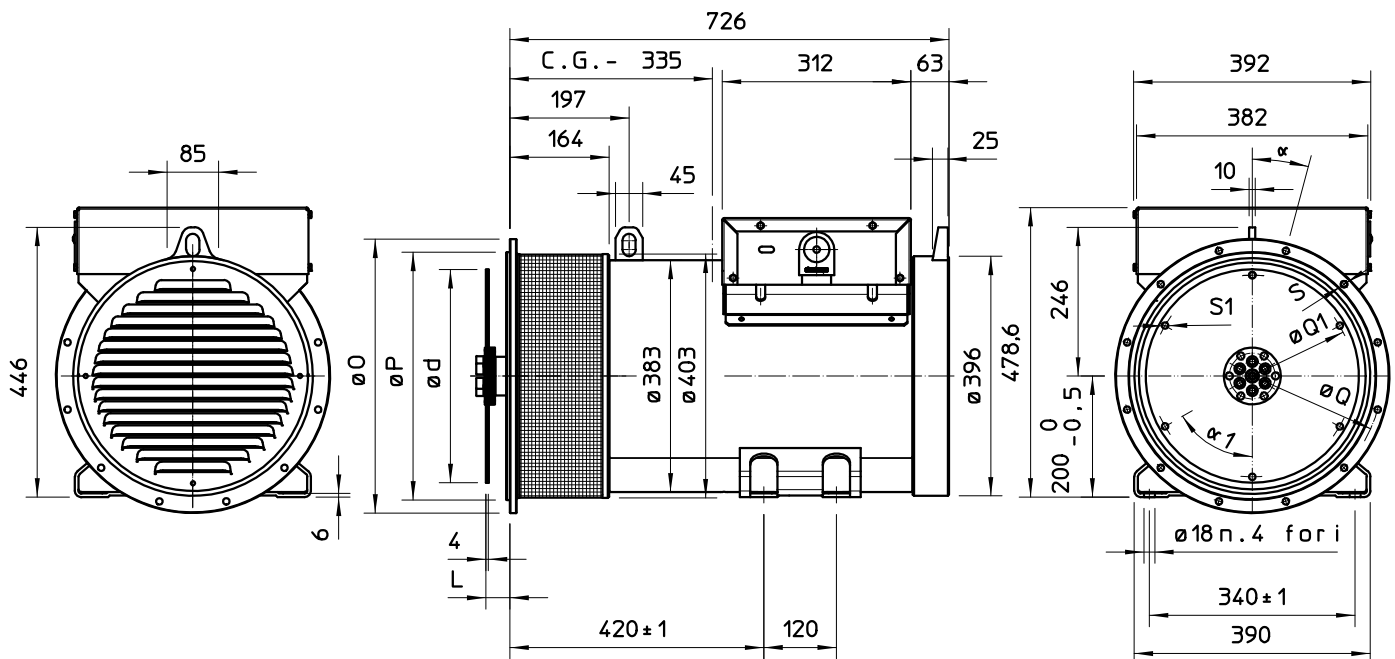

SAE No	DISC COUPLING					
	L	d	Q1	No holes	S1	a1
6,5	30,2	215,9	200	6	9	60°
7,5	30,2	241,3	222,25	8	9	45°
8	62	263,52	244,47	6	11	60°
10	53,8	314,32	295,27	8	11	45°
11,5	39,6	352,42	333,37	8	11	45°

SAE No	FLANGE					
	O	P	Q	No holes	S	a
5	356	314,3	333,4	8	11	22°30'
4	403	362	381	12	11	15°
3	451	409,6	428,6	12	11	15°
2	489	447,7	466,7	12	11	15°
1	552	511,2	530,2	12	11	15°

C.G. = GRAVITY CENTER