



GENERATOR TYPE ECO 38-1LN/4

Document : DS073A/1

issue 004 date 28/10/2013

Electrical Characteristics										
Frequency	Hz	50				60				
Voltage (series star)	V	380	400	415	440	415	440	460	480	
Rated power class H	kVA	250	250	250	230	290	300	300	300	
	kW	200	200	200	184	232	240	240	240	
Rated power class F	kVA	230	230	230	215	270	280	280	280	
	kW	184	184	184	172	216	224	224	224	
Regulation with DSR		±1 % with any power factor and speed variations between -5% +30%								
Insulation class		H								
Execution		Brushless								
Stator winding		12 ends								
Rotor		with damping cage								
Efficiencies class H	4/4	%	93,3	93,4	93,1	92,9	93,8	94,3	94,4	94,5
(see graph. for details)	3/4	%	93,4	93,7	93,6	93,3	94,3	94,5	94,7	94,9
	2/4	%	92,3	92,4	92,4	92,2	93,4	93,5	93,6	93,7
	1/4	%	90,1	89,9	89,7	89,5	90,6	90,6	90,6	90,4
Reactances (f. l.cl. F)	Xd	%	229,4	207	192,3	157,4	267,7	246,3	225,4	207
	Xd'	%	15,5	14,0	13,0	10,6	18,1	16,7	15,2	14,0
	Xd''	%	8,0	7,2	6,7	5,5	9,3	8,6	7,8	7,2
	Xq	%	129,6	117	108,7	89,0	151,3	139,2	127,4	117
	Xq'	%	129,6	117	108,7	89,0	151,3	139,2	127,4	117
	Xq''	%	24,4	22	20,4	16,7	28,5	26,2	24,0	22
	X ₂	%	17,7	16,0	14,9	12,2	20,7	19,0	17,4	16,0
	X ₀	%	2,7	2,4	2,2	1,8	3,1	2,9	2,6	2,4
Short Circuit Ratio	Kcc		0,41	0,44	0,68	1,11	0,32	0,38	0,41	0,44
Time Constants	Td'	sec.	0,085							
	Td''	sec.	0,013							
	Tdo'	sec.	1,30							
	Tα	sec.	0,017							
Short Circuit Current Capacity		%	>300				>350			
Excitation at no load	Amp.		0,6	0,71	0,8	0,95	0,4	0,5	0,58	0,7
Excitation at full load	Amp.		2,7	2,8	3	3,2	2,4	2,6	2,7	2,8
Overload (long-term)		%	1 hour in a 6 hours period 110% rated load							
Overload per 20 sec.		%	300							
Stator Winding Resistance (20 °C)		Ω	0,0065							
Rotor Winding Resistance (20 °C)		Ω	4,887							
Exciter Resistance (20 °C)		Ω	Rotor : 0,685				Stator : 15,28			
Heat dissipation at f.l.cl.H	W		14362	14133	14823	14062	15335	14507	14237	13968
Telephone Interference			THF < 2%				TIF < 40			
Radio interference			EN61000-6-3, EN61000-6-2. For others standards apply to factory							
Waveform Distors.(THD) at f. load	LL/LN %		2 / 2,1							
Waveform Distors.(THD) at no load	LL/LN %		2,9 / 3,1							
Mechanical characteristics										
Protection			IP 21 (other protection on request)							
DE bearing			6318.2RS							
NDE bearing			6314.2RS							
Weight of wound stator assembly	kg		231							
Weight of wound rotor assembly	kg		147,5							
Weight of complete generator	kg		680							
Maximun overspeed	rpm		2250							
Unbalanced magnetic pull at f.l.cl.F	kN/mm		5,1							
Cooling air requirement	m ³ /min		32				39			
Inertia Constant (H)	sec.		0,116				0,139			
Noise level at 1m/7m	dB(A)		82 / 69				86 / 73			

All technical data are to be considered as a reference and they can be modified without any notice

This document is a propriety of Mecc Alte S.p.a..All rights reserved.



GENERATOR TYPE ECO 38-1LN/4

Document : DS073A/2

issue 004 date : 28/10/2013

50 Hz

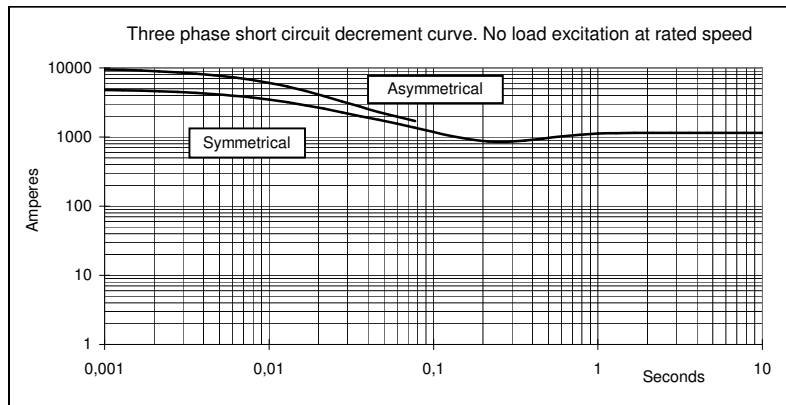
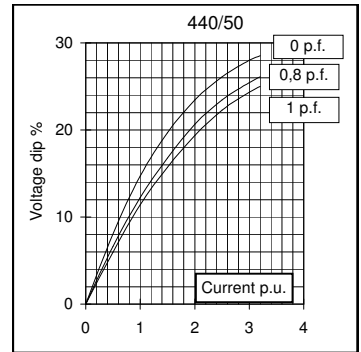
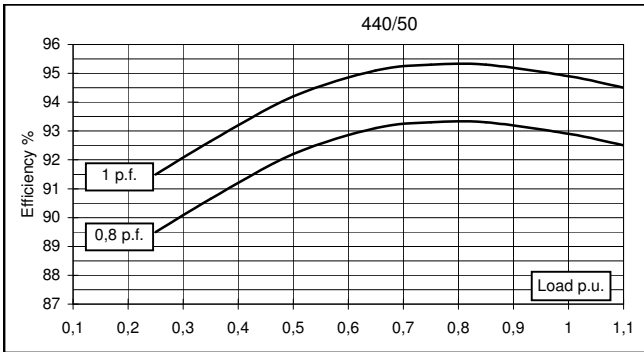
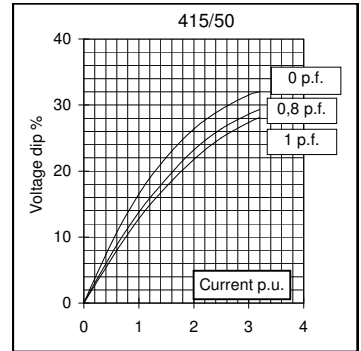
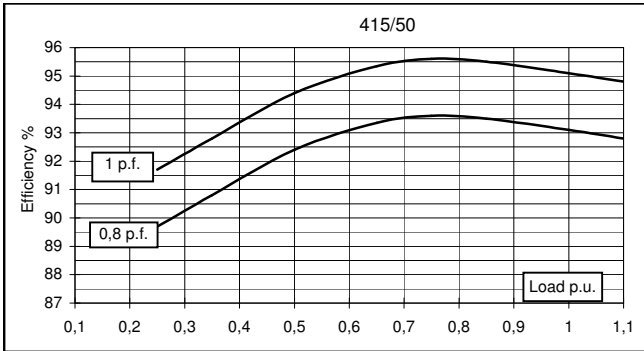
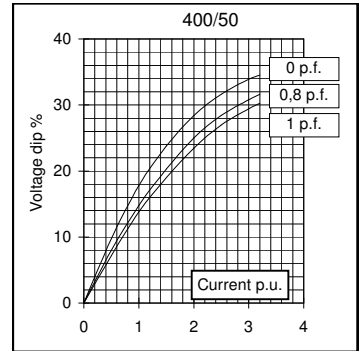
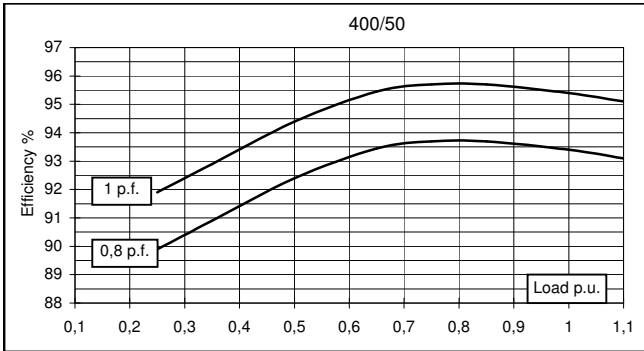
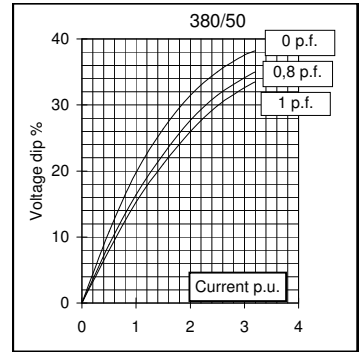
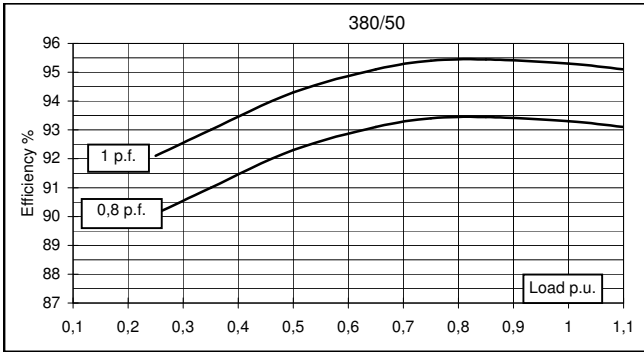



GENERATOR TYPE ECO 38-1LN/4

Document : DS073A/3

issue 004 date : 28/10/2013

60 Hz

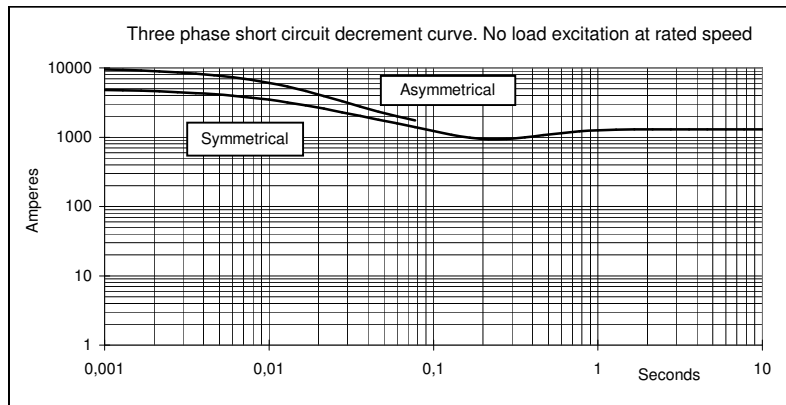
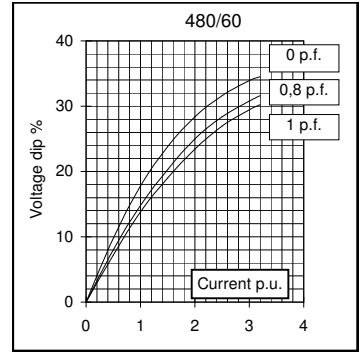
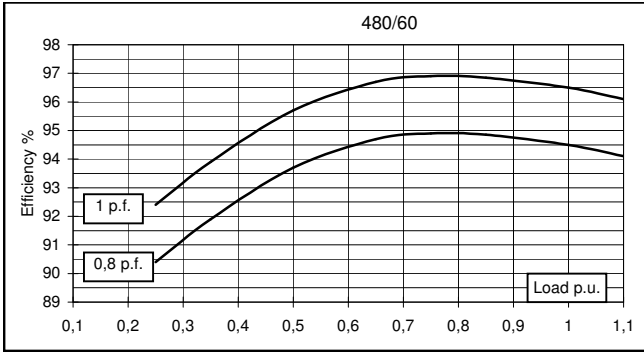
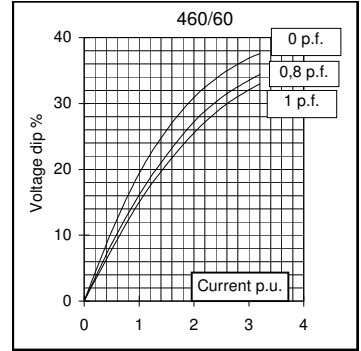
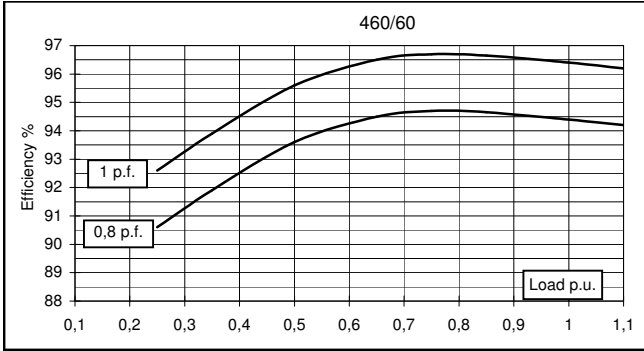
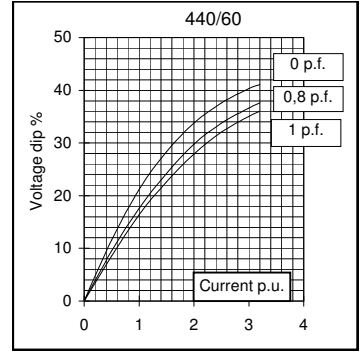
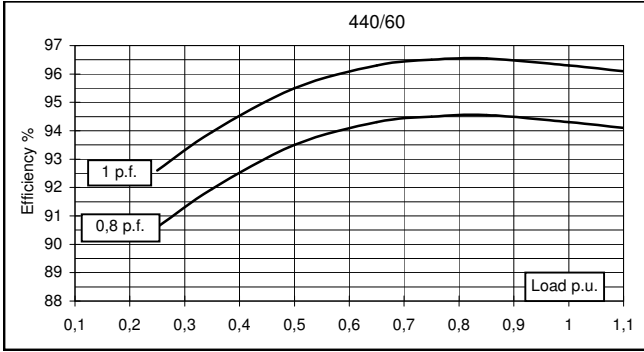
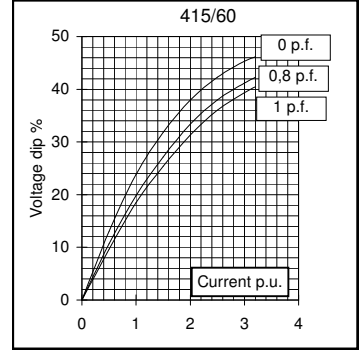
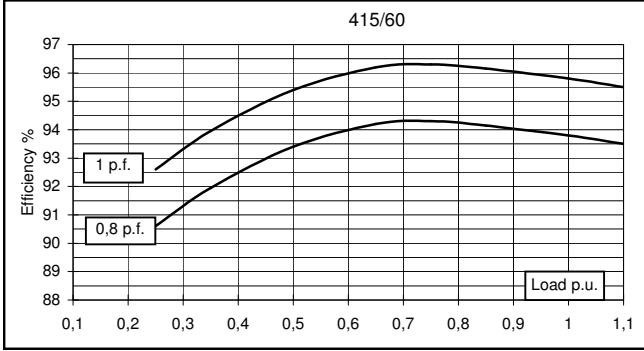

TWO BEARING MOMENTS OF INERTIA

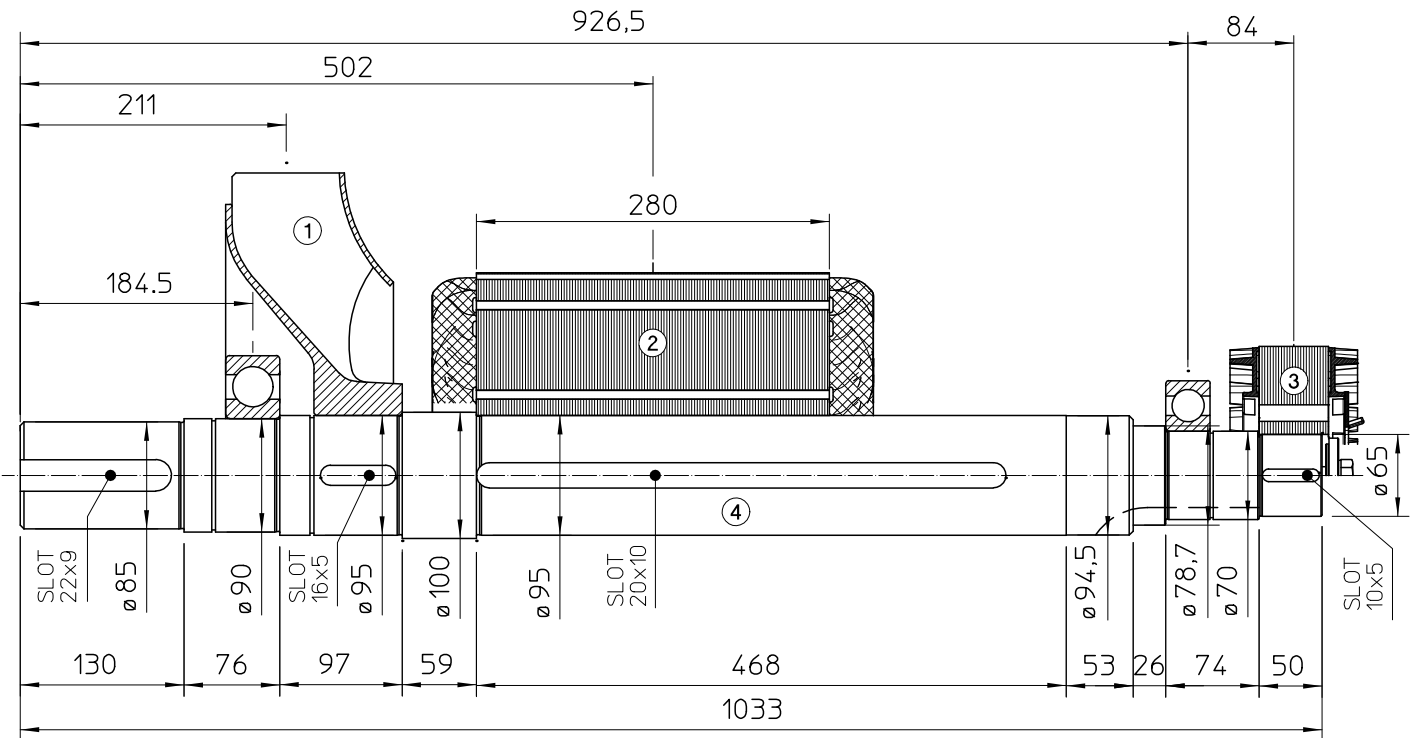

POS.	COMPONENT	WEIGHT (kg)	J (kgm ²)
1	FAN	6.1	0.1887
2	MAIN ROTOR	147.5	2.0195
3	EX. ROTOR	14.5	0.0874
4	SHAFT	49.9	0.0525
TOTAL		218	2.3481

TWO BEARING DIMENSIONS

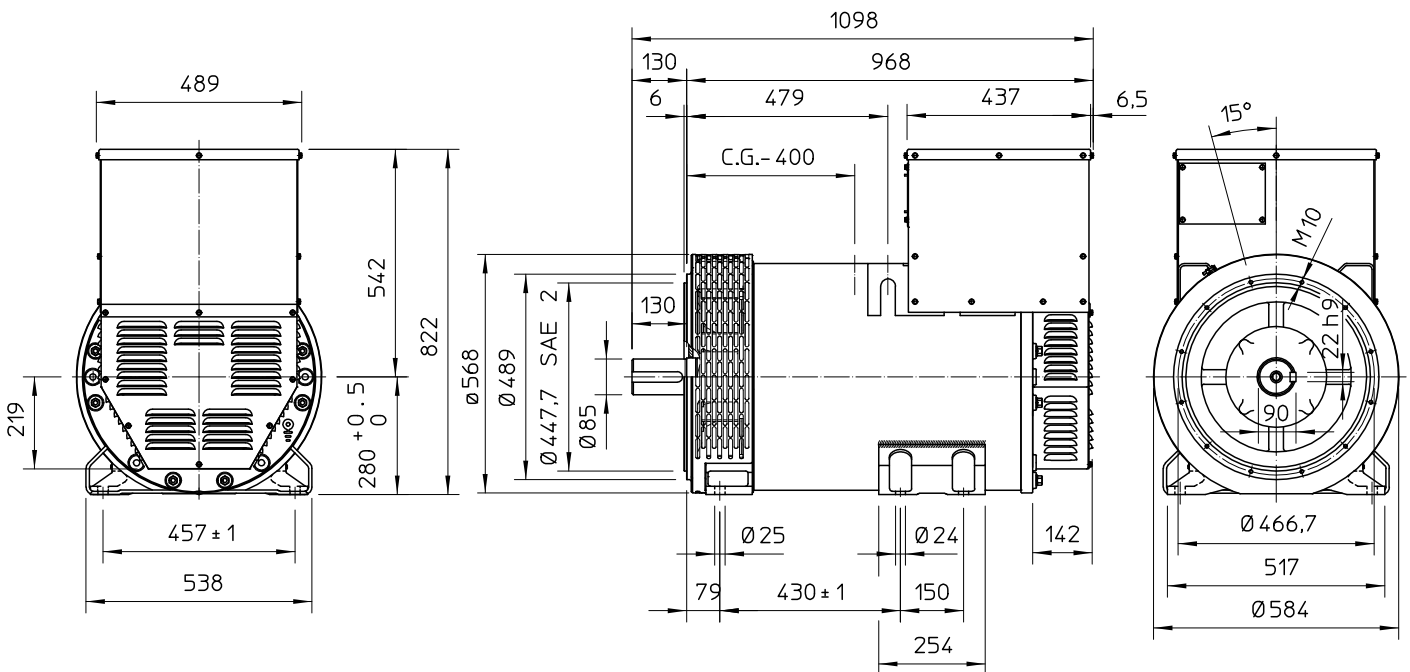

SINGLE BEARING MOMENTS OF INERTIA

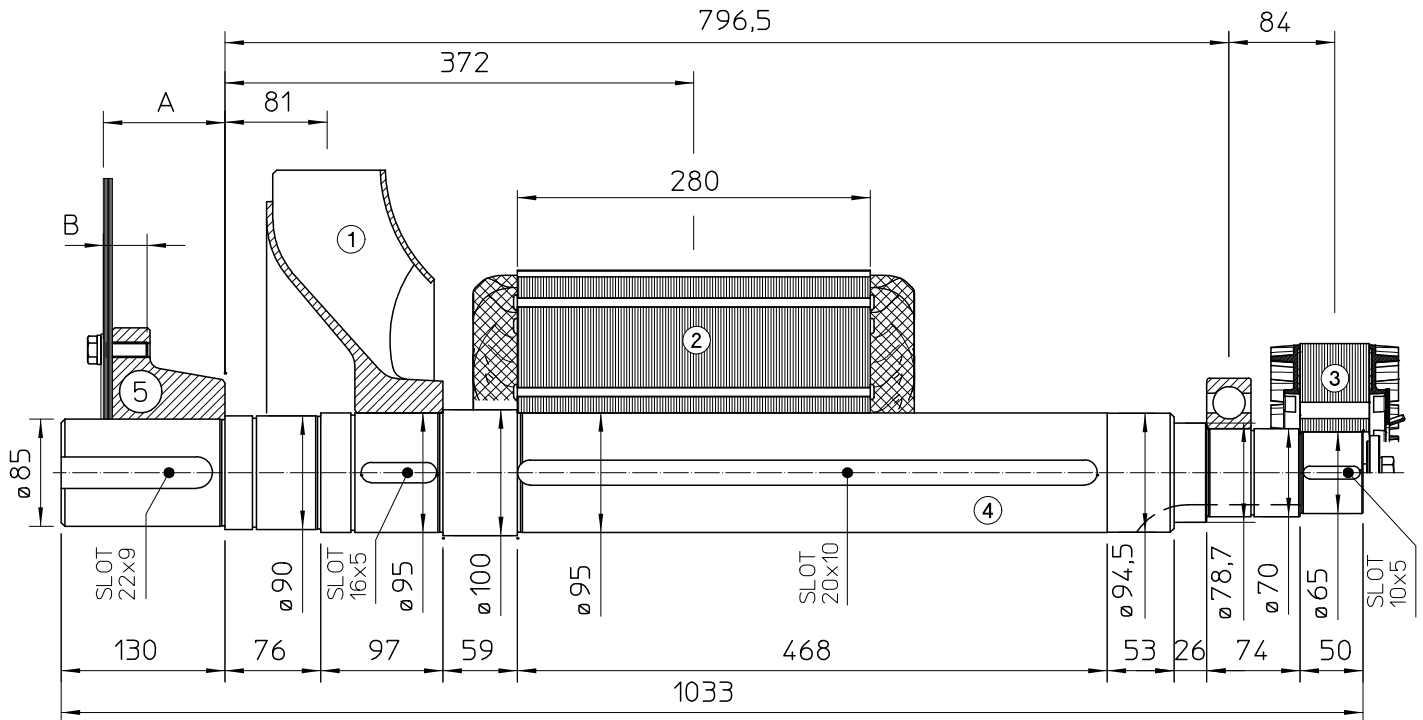

POS.	COMPONENT	WEIGHT (kg)	J (kgm ²)
1	FAN	6.1	0.1887
2	MAIN ROTOR	147.5	2.0195
3	EX. ROTOR	14.5	0.0874
4	SHAFT	49.9	0.0525
TOTAL		218	2.3481

SAE N°	5		SHAFTS COUPLING FLEX PLATE	
	A	B	WEIGHT kg	J kgm ²
11.5	110.4	41.1	20.5	0.174
14	96.4	34.7	23.5	0.275

SINGLE BEARING DIMENSIONS

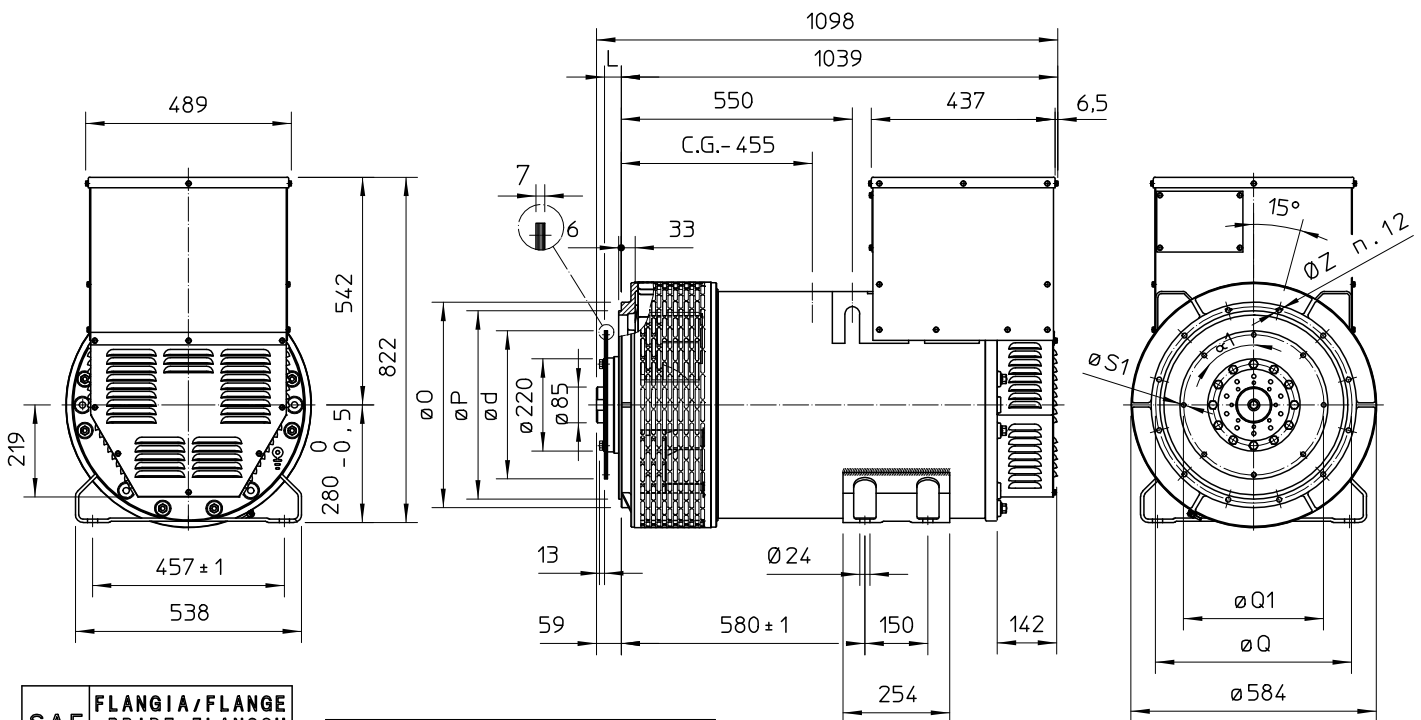

SAE N.	FLANGIA/FLANGE BRIDE/FLANSCH		
	O	P	Q
3	451	409,6	428,6
2	489	447,7	466,7
1	552	511,2	530,2
1/2	648	584,2	619,1

SAE N.	GIUNTI A DISCHI DISC COUPLING DISQUE DE MONOPALIER SCHEIBENKUPPLUNG				
	L	d	Q1	n _{fori}	S1
11 1/2	39,6	352,42	333,37	8	11 45°
14	25,4	466,72	438,15	8	14 45°

C.G.= GRAVITY CENTER