



GENERATOR TYPE ECO 46-1L/4

Document : **DS062A/1**
 issue 004 date 01/04/2014

Electrical Characteristics										
Frequency	Hz	50				60				
Voltage (parallel star)	V	380	400	415	440	415	440	460	480	
Rated power class H	kVA	2100	2100	2100	1850	2300	2390	2520	2520	
	kW	1680	1680	1680	1480	1840	1912	2016	2016	
Rated power class F	kVA	1900	1900	1900	1660	2070	2150	2280	2280	
	kW	1520	1520	1520	1328	1656	1720	1824	1824	
Regulation with DER1		±1% with any power factor and speed variations between -5% +30%								
Insulation class		H								
Execution		Brushless								
Stator winding		12 ends								
Rotor		with damping cage								
Efficiencies class H	4/4	%	96,7	96,6	96,4	96,2	96,5	96,7	96,9	96,8
(see graph. for details)	3/4	%	97,1	96,8	96,9	96,4	96,6	96,9	97,3	97
	2/4	%	96,5	96,4	96,4	95,8	96,1	96,5	96,7	96,6
	1/4	%	95,6	95,6	95,4	94,9	95,3	95,9	95,8	95,9
Reactances (f. l.cl. F)										
	Xd	%	270,4	244	226,7	187	288	273,8	265,7	244
	Xd'	%	26,9	24,3	22,6	18,7	28,7	27,27	26,5	24,3
	Xd''	%	13,1	11,8	11,0	9,1	13,9	13,24	12,8	11,8
	Xq	%	189,5	171	158,9	132	202	191,9	186,2	171
	Xq'	%	189,5	171	158,9	132	202	191,9	186,2	171
	Xq''	%	29,4	26,5	25	20,7	31,3	29,7	28,9	26,5
	X ₂	%	18,6	16,8	15,6	12,9	19,8	18,85	18,3	16,8
	X ₀	%	4,1	3,7	3	2,5	4,4	4,15	4,0	3,7
Short Circuit Ratio	Kcc		0,37	0,41	0,44	0,53	0,34	0,37	0,38	0,41
Time Constants	Td'	sec.	0,265							
	Td''	sec.	0,0225							
	Tdo'	sec.	11,0							
	Tα	sec.	0,031							
Short Circuit Current Capacity		%	>300				>350			
Excitation at no load	Amp.		0,7	0,8	0,9	1,1	0,4	0,5	0,65	0,75
Excitation at full load	Amp.		2,8	2,9	3	3,1	2,6	2,7	2,7	2,8
Overload (long-term)	%	1 hour in a 6 hours period 110% rated load								
Overload per 20 sec.	%	300								
Stator Winding Resistance (20°C)	Ω	0,0032								
Rotor Winding Resistance (20°C)	Ω	3,977								
Exciter Resistance (20 °C)	Ω	Rotor : 0,120				Stator : 12,90				
Heat dissipation at f.l.cl.H	W	57332	59130	62739	58462	66736	65249	64495	66645	
Telephone Interference		THF < 2%				TIF < 40				
Radio interference		EN61000-6-3, EN61000-6-2. For others standards apply to factory								
Waveform Distors.(THD) at f. load	LL/LN %	3,3 / 2,9								
Waveform Distors.(THD) at no load	LL/LN %	2,7 / 2,6								
Mechanical characteristics										
Protection		IP 21 (other protection on request)								
DE bearing		6330								
NDE bearing		6324								
Weight of wound stator assembly	kg	1571								
Weight of wound rotor assembly	kg	1034								
Weight of complete generator	kg	3810								
Maximun overspeed	rpm	2250								
Unbalanced magnetic pull at f.l.cl.F	kN/mm	6,8								
Cooling air requirement	m³/min	135				162				
Inertia Constant (H)	sec.	0,312				0,374				
Noise level at 1m/7m	dB(A)	97 / 86				100 / 91				

All technical data are to be considered as a reference and they can be modified without any notice.

This document is a propriety of Mecc Alte S.p.A.. All rights reserved.

50 Hz

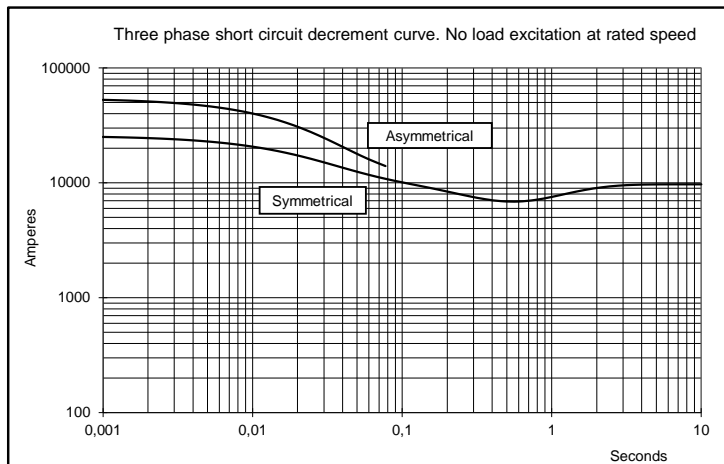
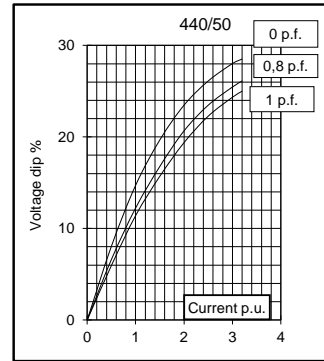
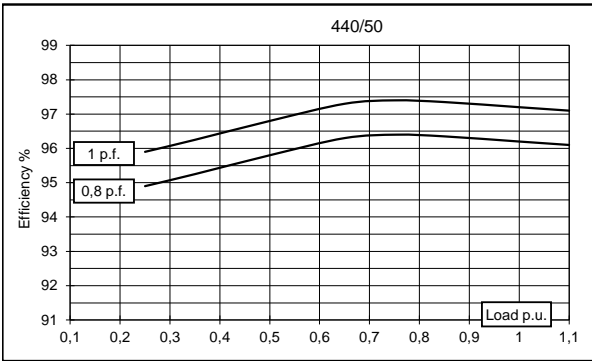
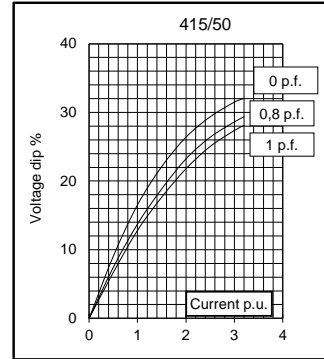
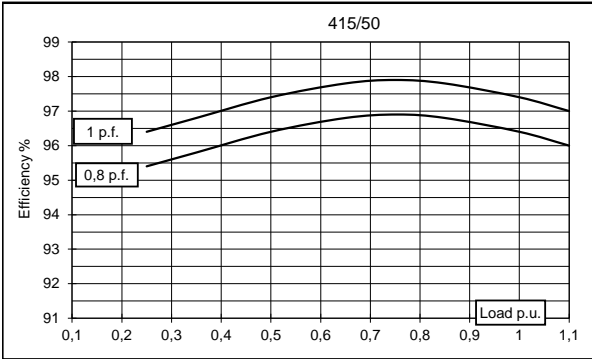
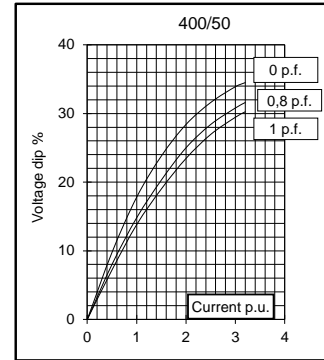
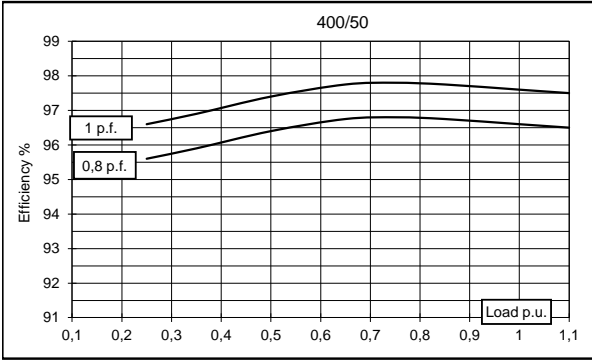
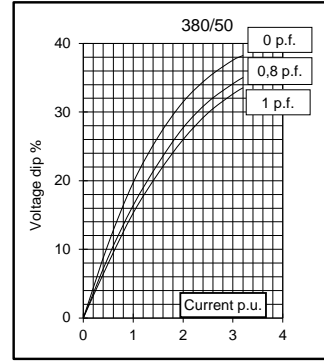
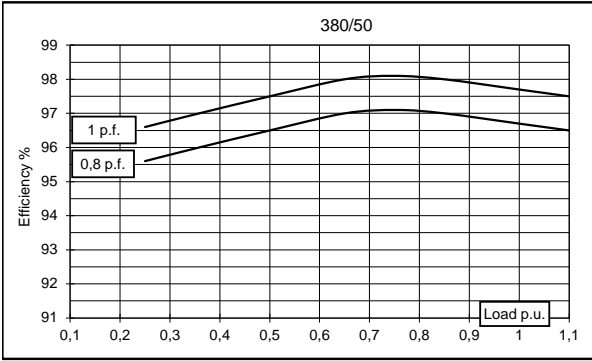

60 Hz

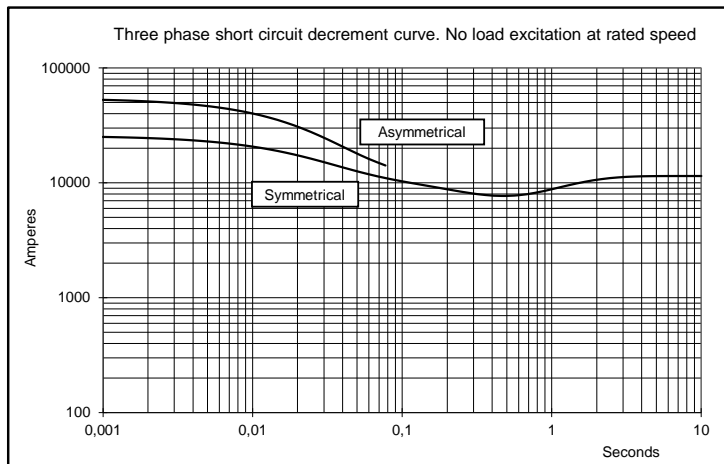
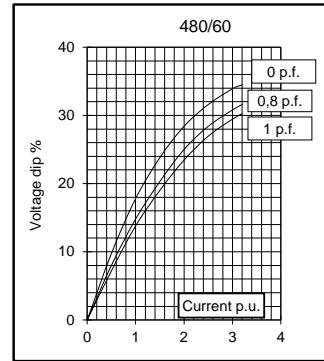
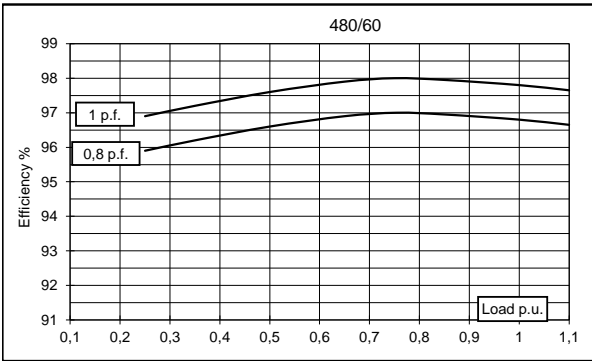
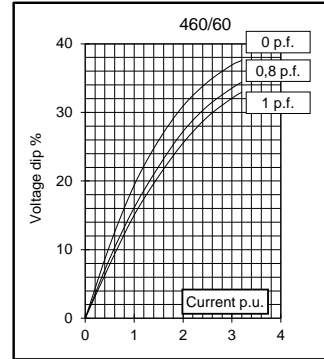
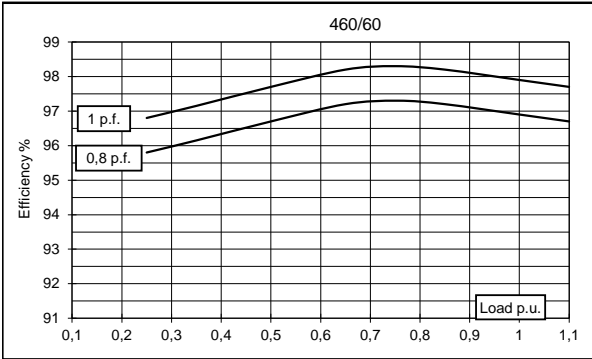
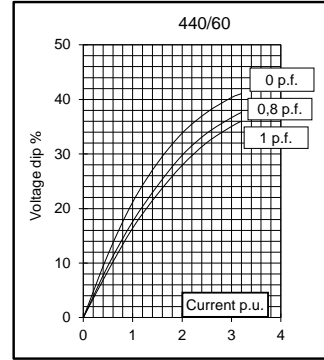
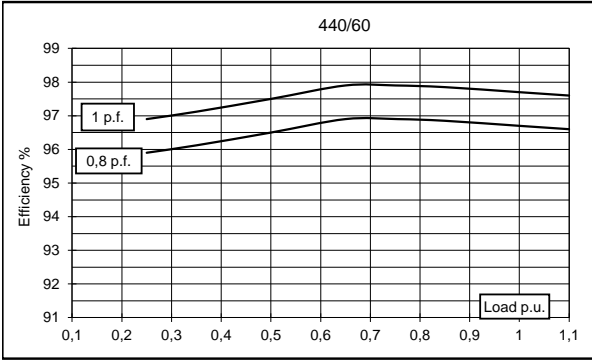
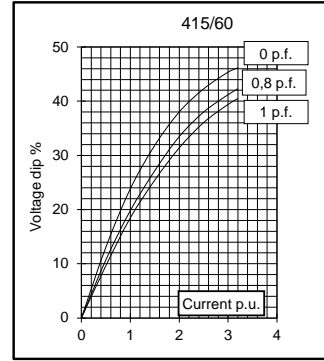
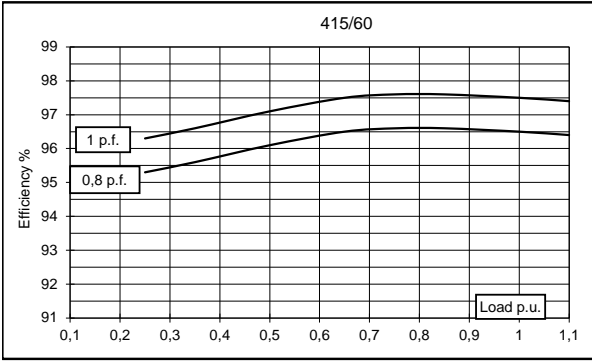

TWO BEARING MOMENTS OF INERTIA

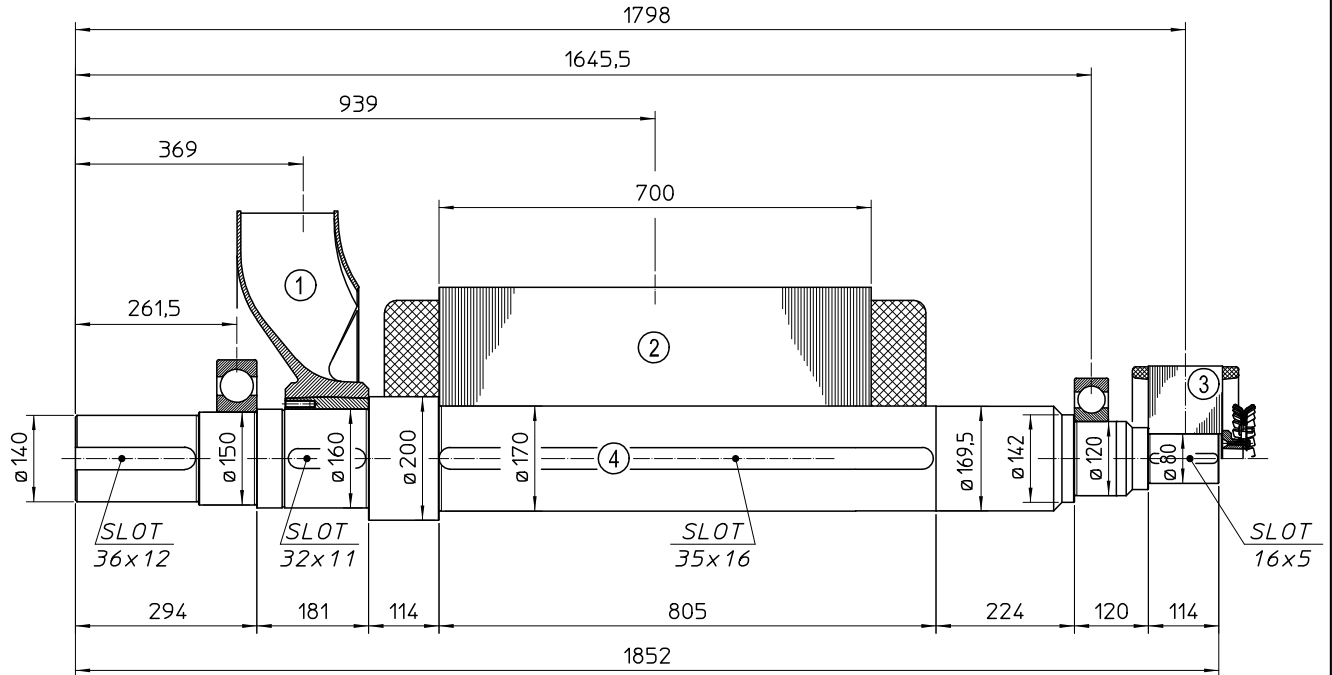

POS.	COMPONENT	WEIGHT (kg)	J (kgm ²)
1	FAN	42.7	2.250
2	MAIN ROTOR	1034	40.350
3	EX. ROTOR	60	0.730
4	SHAFT	288	0.985
TOTAL		1424.7	44.315

TWO BEARING DIMENSIONS

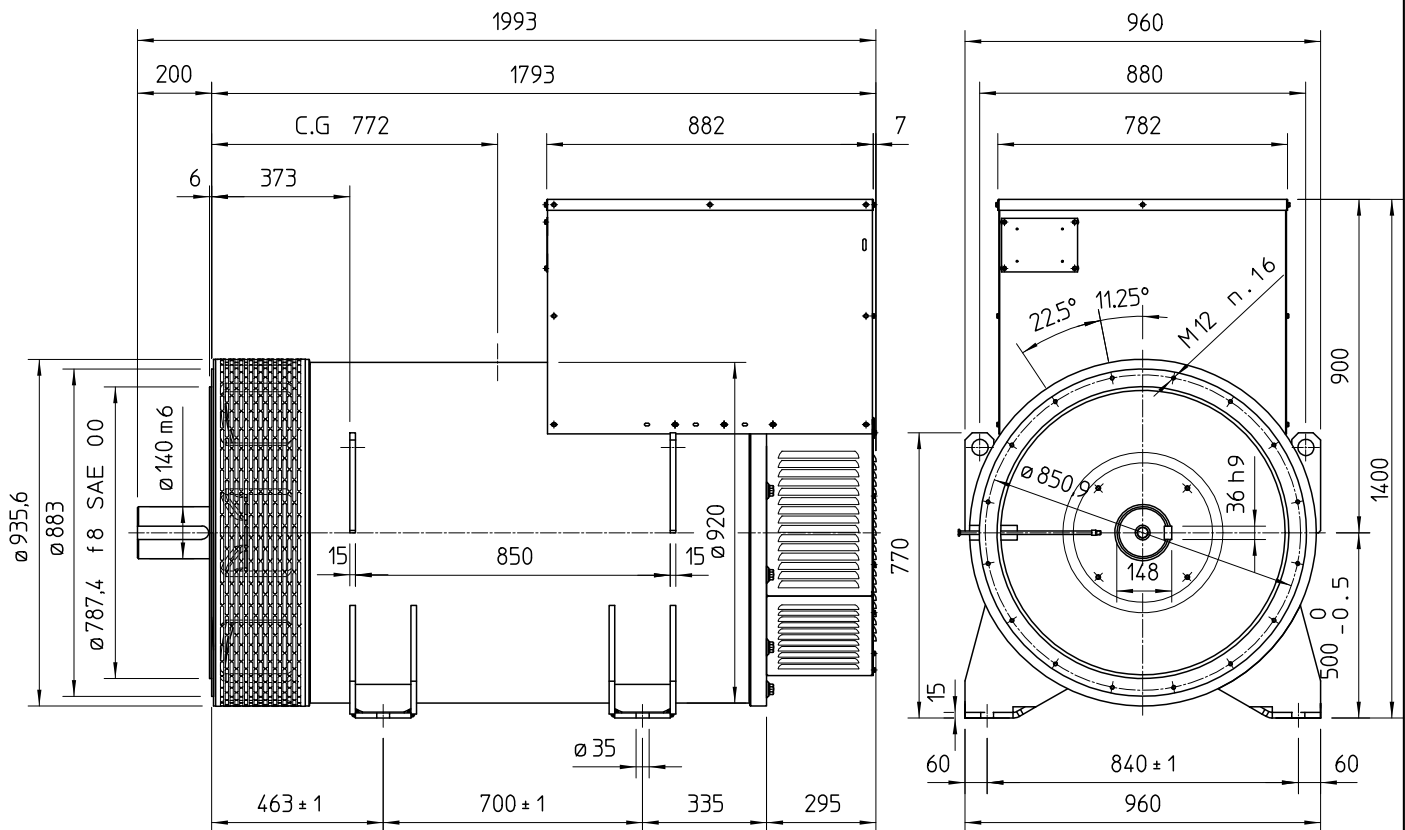

C.G.= GRAVITY CENTER

SINGLE BEARING MOMENTS OF INERTIA

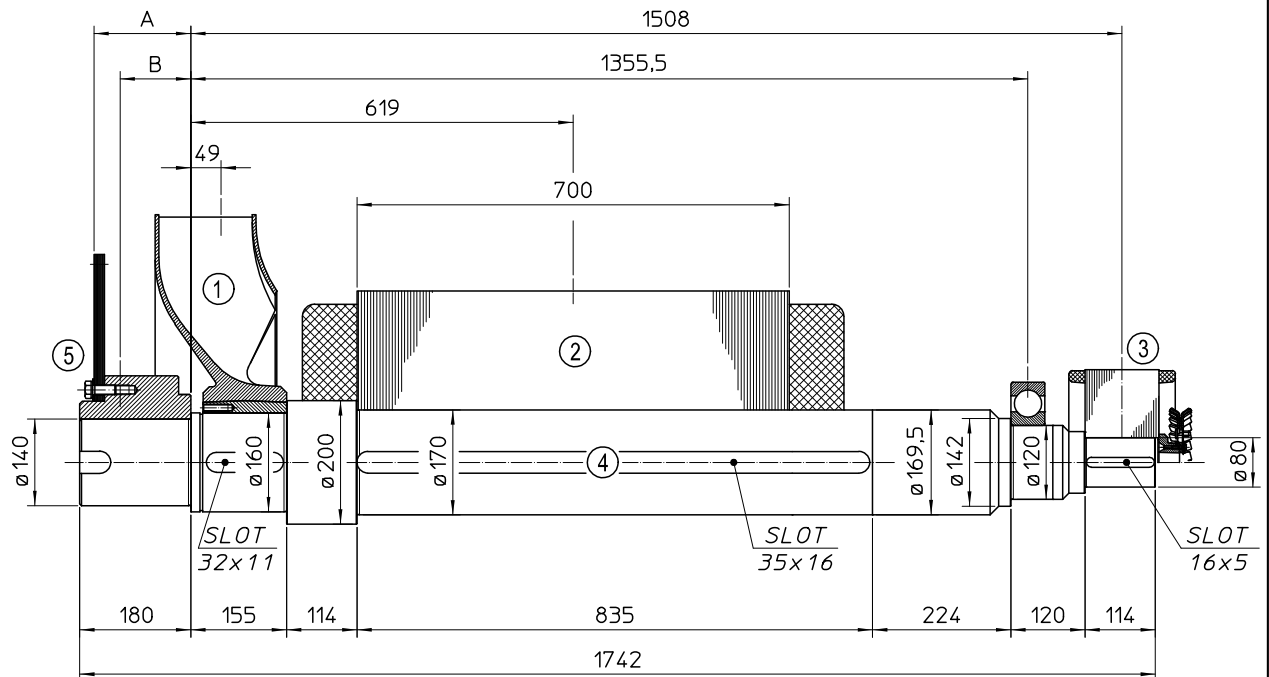

POS.	COMPONENT	WEIGHT (kg)	J (kgm ²)
1	FAN	42.7	2,250
2	MAIN ROTOR	1034	40.350
3	EX. ROTOR	60	0,730
4	SHAFT	269.5	0.934
TOTAL		1406.2	44.264

SAE N°	5		SHAFTS COUPLING FLEX PLATE	
	A	B	WEIGHT kg	J kgm ²
18	172.7	113.4	82.7	1.863
21	157	114.6	93,6	3,206

SINGLE BEARING DIMENSIONS

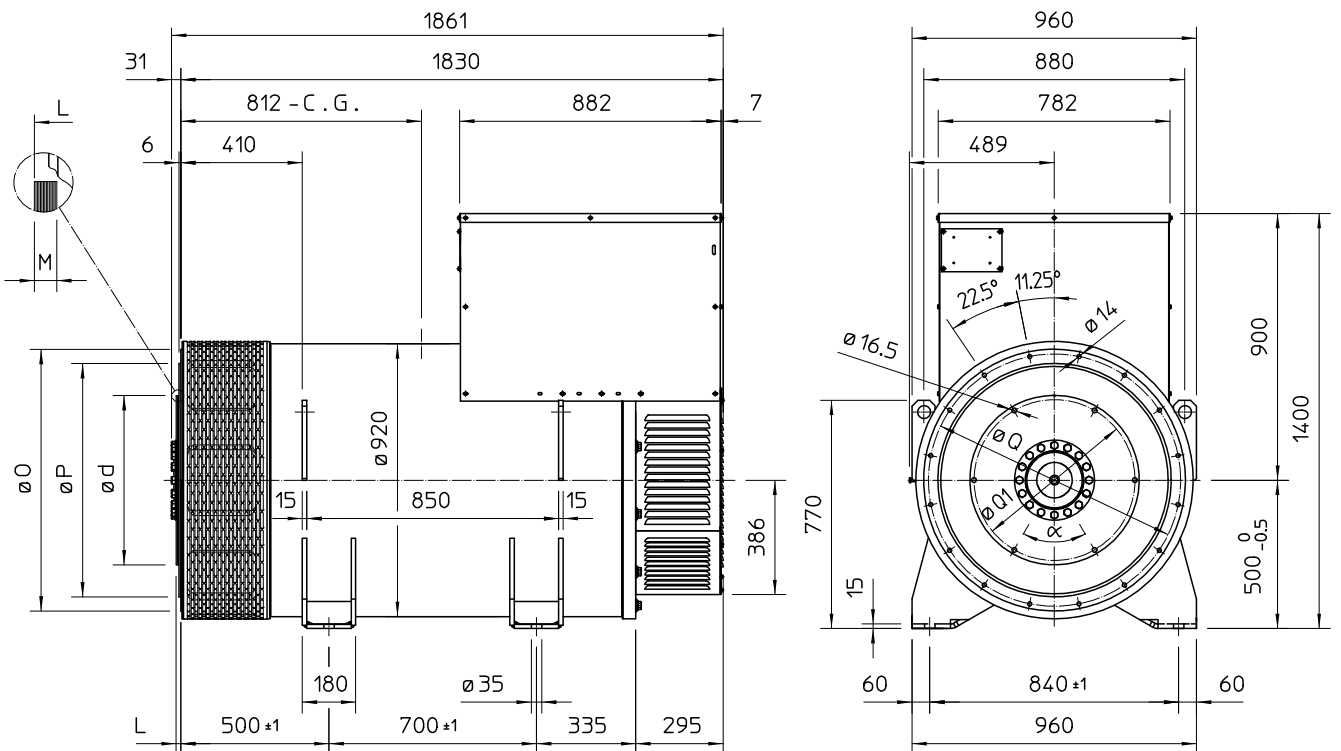

SAE N°	FLANGE		
	O	P	Q
0	711	647.7	679.5
00	883	787.4	850.9

SAE N°	DISC COUPLING						
	d	L	M	Q1	HOLES N°	α	
18	571.5	15.7	15	542.92	6	60°	
21	673.1	0	17	641.35	12	30°	

C.G.= GRAVITY CENTER