



**GENERATOR TYPE ECO 46-2S/4**

Document : **DS061A/1**

issue 004 date 01/04/2014

<b>Electrical Characteristics</b>										
Frequency	Hz	50				60				
Voltage (parallel star)	V	380	400	415	440	415	440	460	480	
Rated power class H	kVA	1800	1800	1800	1600	1950	2050	2160	2160	
	kW	1440	1440	1440	1280	1560	1640	1728	1728	
Rated power class F	kVA	1600	1600	1600	1440	1750	1820	1920	1920	
	kW	1280	1280	1280	1152	1400	1456	1536	1536	
Regulation with DER1		±1% with any power factor and speed variations between -5% +30%								
Insulation class		H								
Execution		Brushless								
Stator winding		12 ends								
Rotor		with damping cage								
Efficiencies class H	4/4	%	96,5	96,4	96,2	96	96,2	96,5	96,7	96,6
(see graph. for details)	3/4	%	96,8	96,5	96,6	96,1	96,3	96,6	97	96,7
	2/4	%	96,3	96,2	96,2	95,7	95,8	96,3	96,5	96,4
	1/4	%	95,6	95,6	95,4	94,9	95	95,6	95,8	95,8
Reactances (f. l.cl. F)	Xd	%	291,6	263,2	244,5	205	320	296,9	286,6	263,2
	Xd'	%	27,6	24,9	23,1	19,4	30,2	28,09	27,1	24,9
	Xd''	%	13,5	12,2	11,3	9,5	15,1	13,76	13,3	12,2
	Xq	%	181,7	164	152,4	128	197	185,0	178,6	164
	Xq'	%	181,7	164	152,4	128	197	185,0	178,6	164
	Xq''	%	30,8	27,8	26	21,8	34,8	31,4	30,3	27,8
	X <sub>2</sub>	%	19,3	17,4	16,2	13,6	21,2	19,63	18,9	17,4
	X <sub>0</sub>	%	4,3	3,9	4	3,4	4,8	4,40	4,2	3,9
Short Circuit Ratio	Kcc		0,34	0,38	0,41	4,9	0,31	0,34	0,35	0,38
Time Constants	Td'	sec.	0,258							
	Td''	sec.	0,023							
	Tdo'	sec.	10,40							
	Tα	sec.	0,029							
Short Circuit Current Capacity		%	>300				>350			
Excitation at no load	Amp.		0,7	0,75	0,8	1	0,5	0,6	0,65	0,7
Excitation at full load	Amp.		2,9	3	3,1	3,2	2,9	2,85	2,9	3
Overload (long-term)	%	1 hour in a 6 hours period 110% rated load								
Overload per 20 sec.	%	300								
Stator Winding Resistance (20°C)	Ω	0,0039								
Rotor Winding Resistance (20°C)	Ω	3,500								
Exciter Resistance (20 °C)	Ω	Rotor : 0,120				Stator : 12,90				
Heat dissipation at f.l.cl.H	W	52228	53776	56881	53333	61622	59482	58970	60820	
Telephone Interference		THF < 2%				TIF < 40				
Radio interference		EN61000-6-3, EN61000-6-2. For others standards apply to factory								
Waveform Distors.(THD) at f. load	LL/LN %	3,4 / 3,3								
Waveform Distors.(THD) at no load	LL/LN %	2,9 / 2,8								
<b>Mechanical characteristics</b>										
Protection		IP 21 (other protection on request)								
DE bearing		6330								
NDE bearing		6324								
Weight of wound stator assembly	kg	1366								
Weight of wound rotor assembly	kg	904								
Weight of complete generator	kg	3565								
Maximun overspeed	rpm	2250								
Unbalanced magnetic pull at f.l.cl.F	kN/mm	6,5								
Cooling air requirement	m³/min	135				162				
Inertia Constant (H)	sec.	0,323				0,387				
Noise level at 1m/7m	dB(A)	97 / 86				100 / 91				

All technical data are to be considered as a reference and they can be modified without any notice.

This document is a propriety of Mecc Alte S.p.A.. All rights reserved.

**50 Hz**

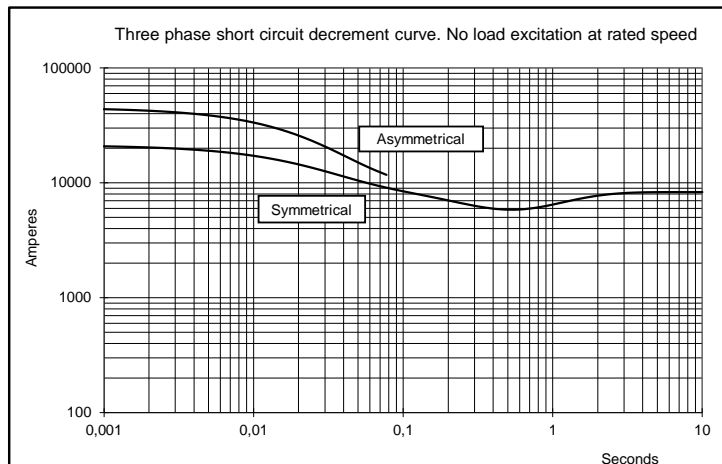
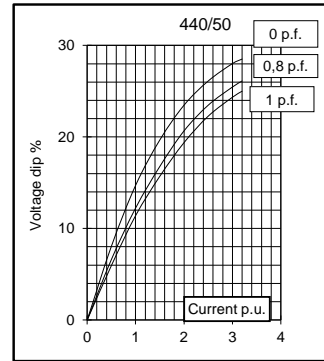
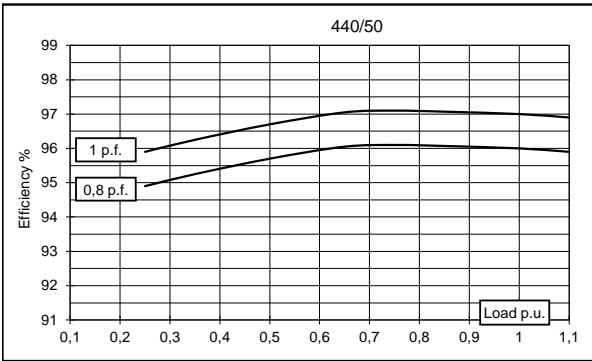
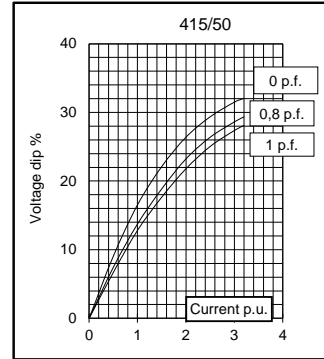
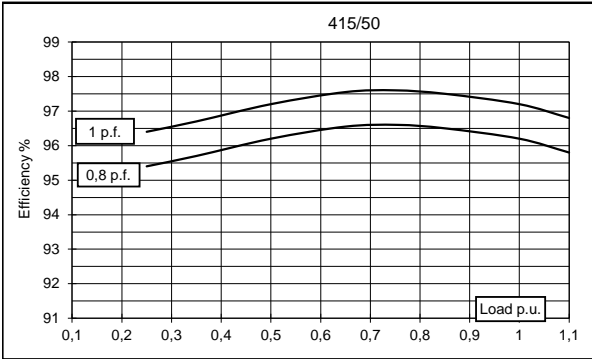
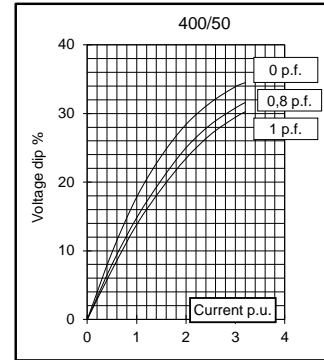
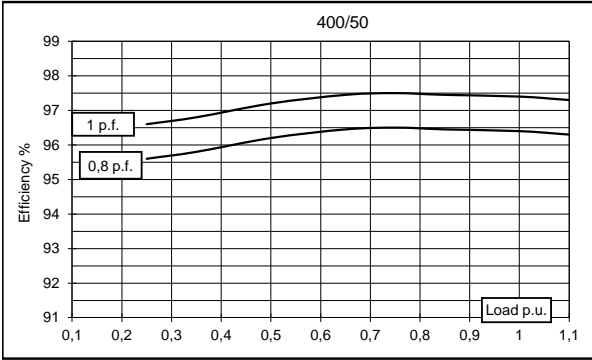
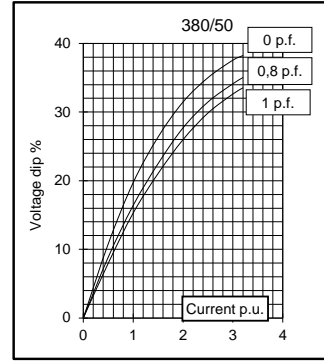
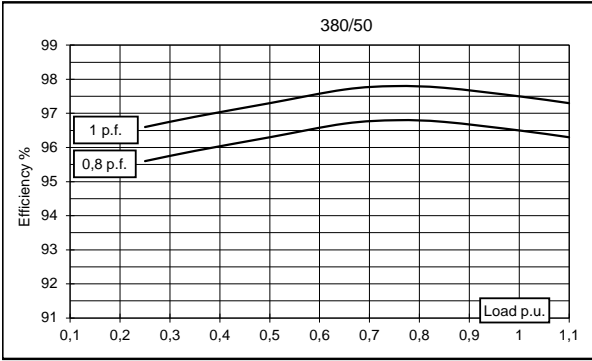

**60 Hz**

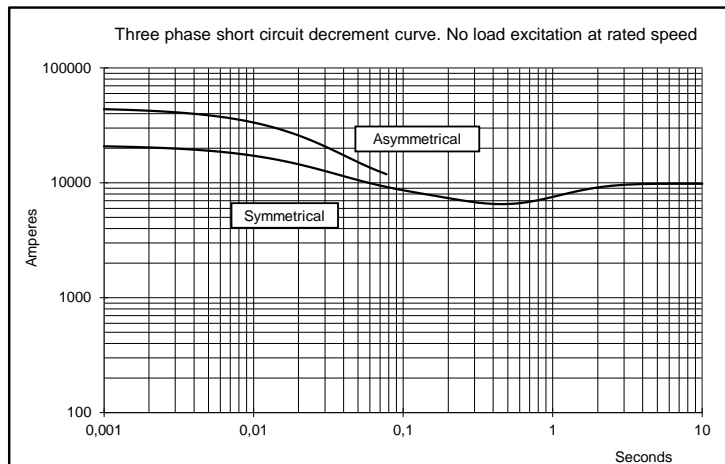
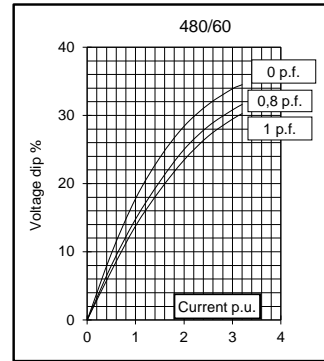
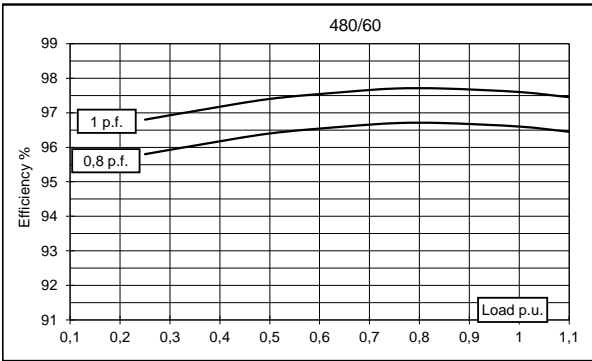
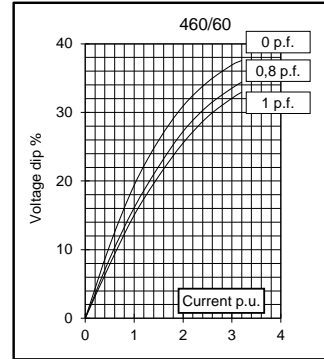
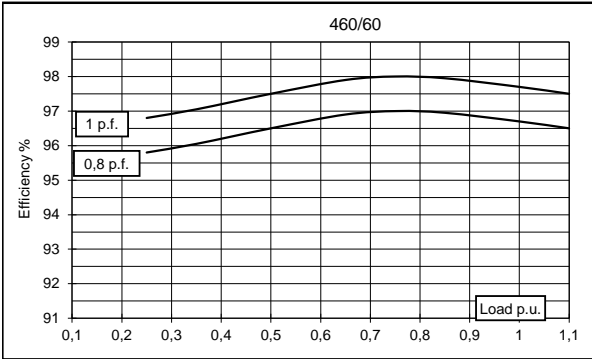
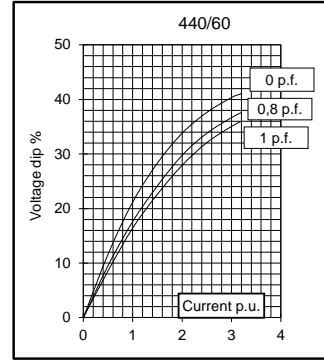
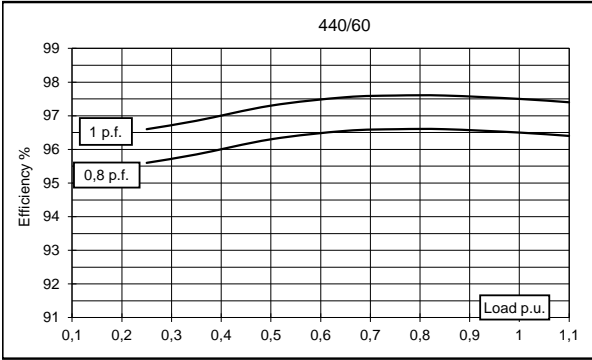
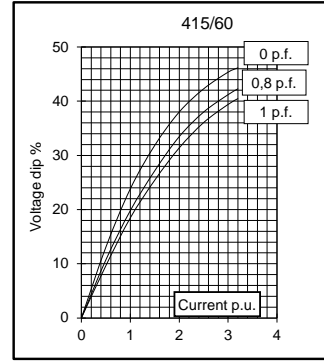
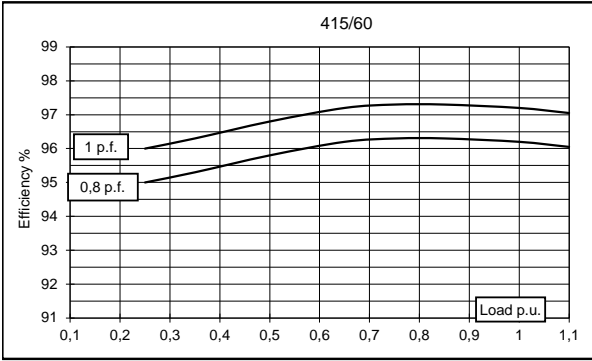

### TWO BEARING MOMENTS OF INERTIA

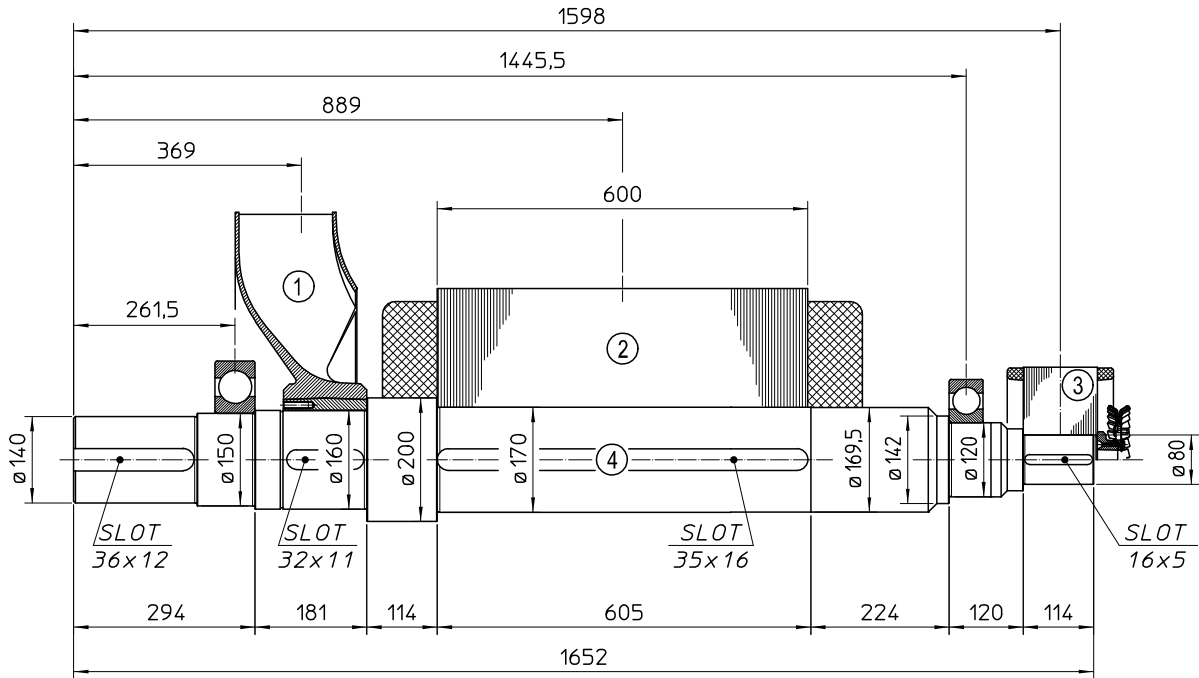

POS.	COMPONENT	WEIGHT (kg)	J (kgm <sup>2</sup> )
1	FAN	42.7	2,250
2	MAIN ROTOR	904	35,337
3	EX. ROTOR	60	0,730
4	SHAFT	248.3	0,844
TOTAL		1255	39,161

### TWO BEARING DIMENSIONS

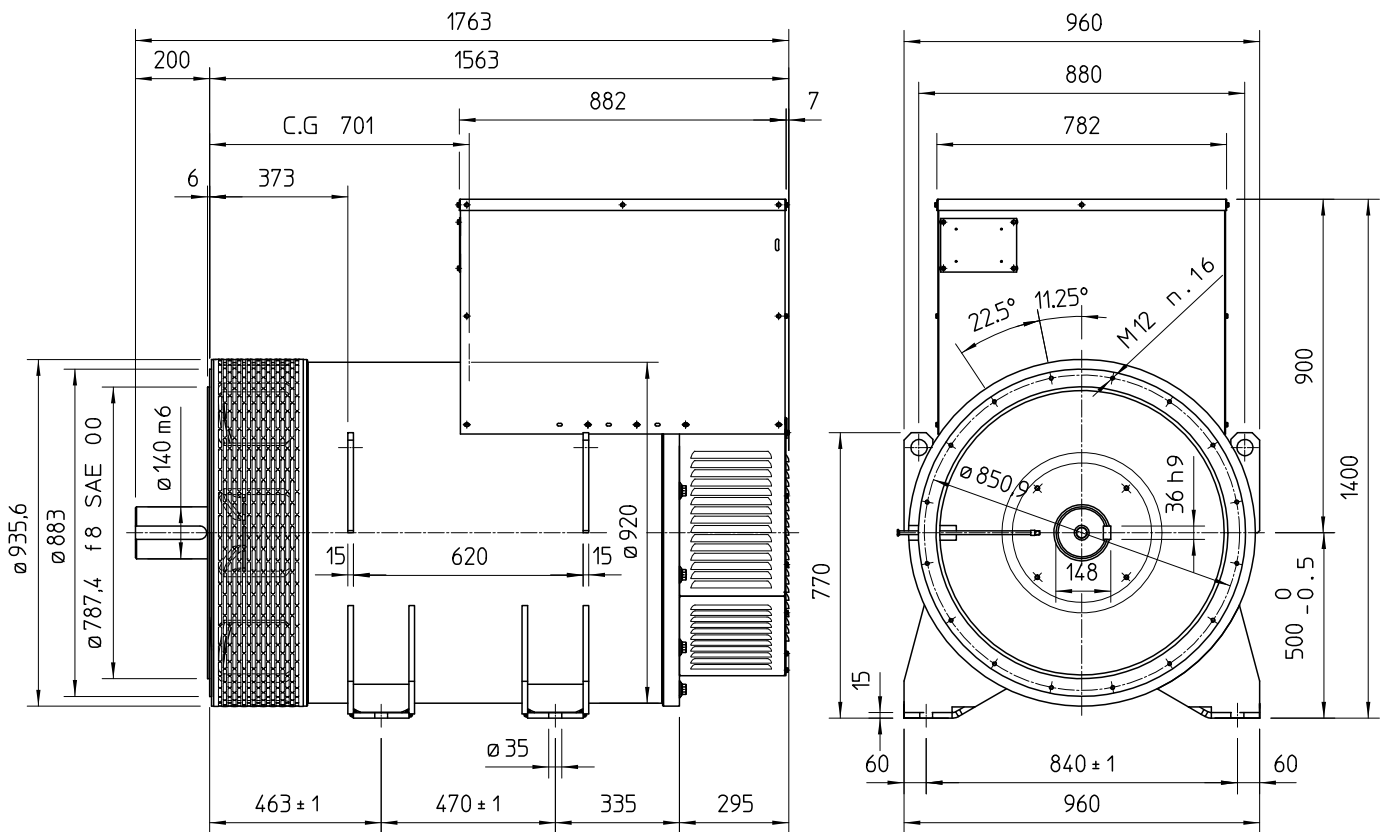

C.G.= GRAVITY CENTER

### SINGLE BEARING MOMENTS OF INERTIA

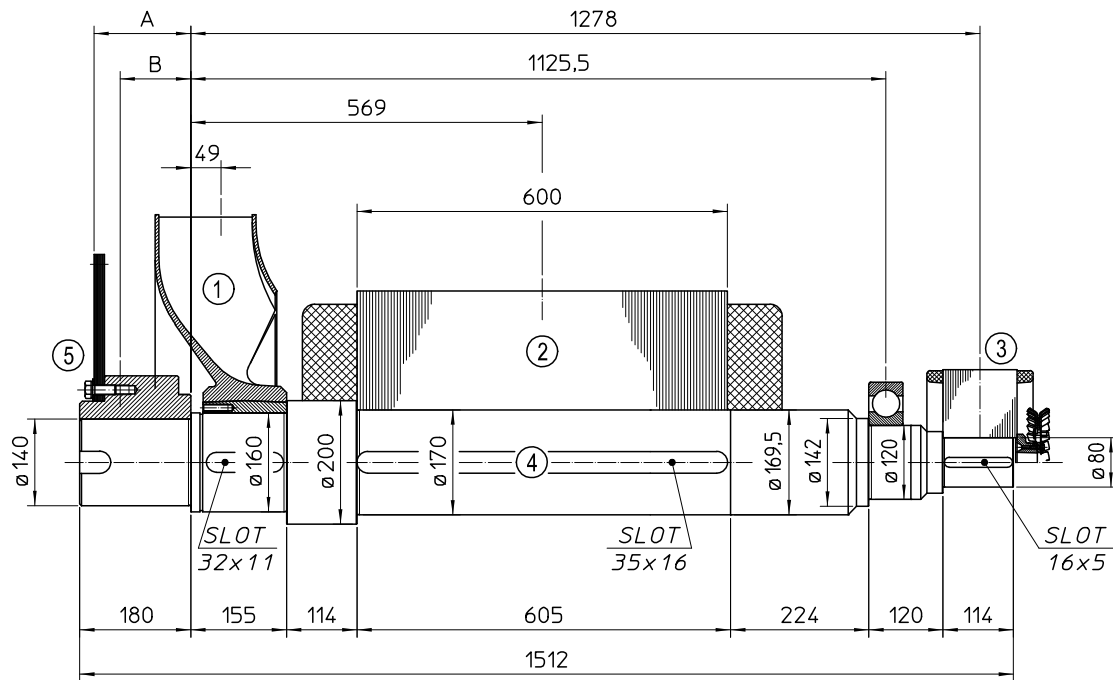

POS.	COMPONENT	WEIGHT (kg)	J (kgm <sup>2</sup> )
1	FAN	42.7	2,250
2	MAIN ROTOR	904	36.337
3	EX. ROTOR	60	0,730
4	SHAFT	230	0,792
TOTAL		1236.7	39.109

SAE N°	5		SHAFTS COUPLING FLEX PLATE	
	A	B	WEIGHT kg	J kgm <sup>2</sup>
18	172.7	113.4	82.7	1.863
21	157	114.6	93.6	3.206

### SINGLE BEARING DIMENSIONS

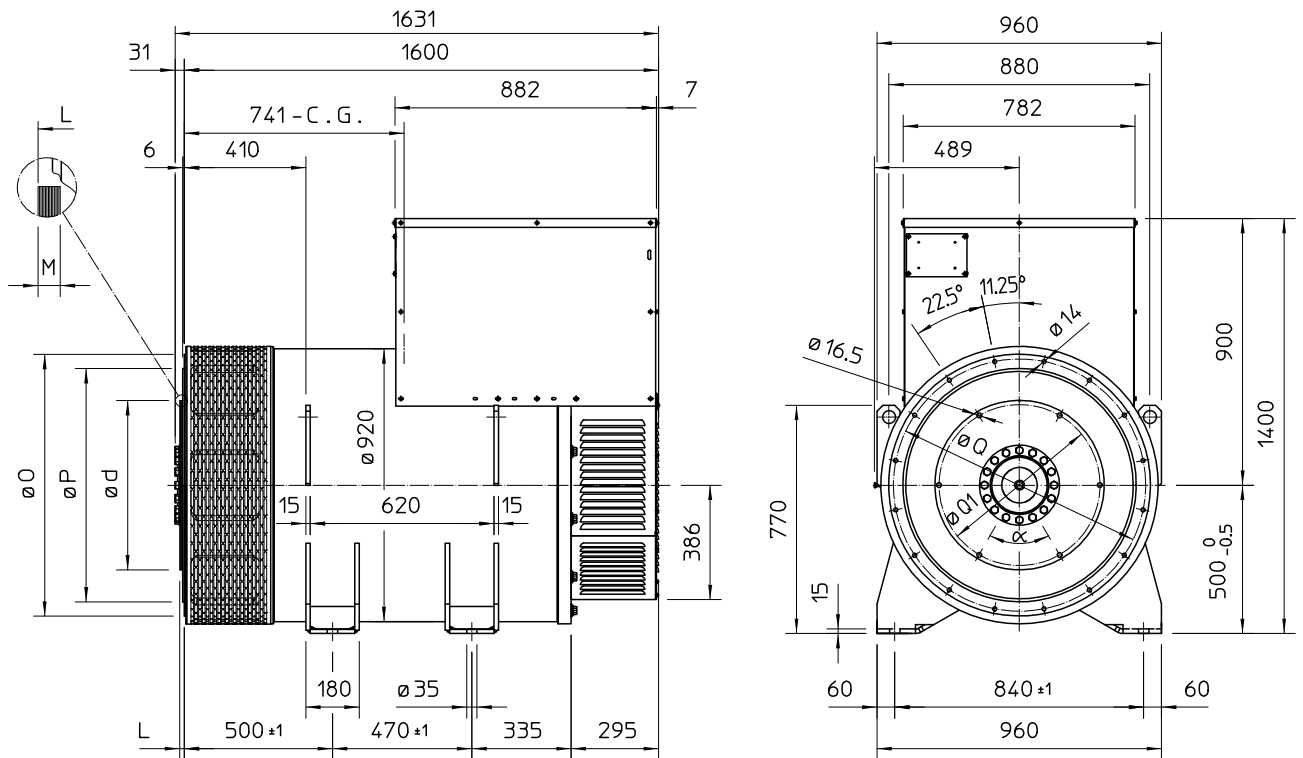

SAE N°	FLANGE		
	O	P	Q
0	711	647.7	679.5
00	883	787.4	850.9

SAE N°	DISC COUPLING						
	d	L	M	Q1	HOLES N°	α	
18	571.5	15.7	15	542.92	6	60°	
21	673.1	0	17	641.35	12	30°	

C.G.= GRAVITY CENTER